



BETONTM -UNO

Matrici per calcestruzzo a faccia vista

BETON UNO™

Indice

Linea matrici *STANDARD*

4

MOD. w01 <i>_Wood Collection</i>	<i>pag</i>	5	MOD. f37 <i>_Form Collection</i>	<i>pag</i>	30
MOD. w02 <i>_Wood Collection</i>	<i>pag</i>	6	MOD. f61 <i>_Form Collection</i>	<i>pag</i>	31
MOD. w03 <i>_Wood Collection</i>	<i>pag</i>	7	MOD. f66 <i>_Form Collection</i>	<i>pag</i>	32
MOD. w04 <i>_Wood Collection</i>	<i>pag</i>	8	MOD. f75 <i>_Form Collection</i>	<i>pag</i>	33
MOD. w05 <i>_Wood Collection</i>	<i>pag</i>	9	MOD. f77 <i>_Form Collection</i>	<i>pag</i>	34
MOD. w06 <i>_Wood Collection</i>	<i>pag</i>	10	MOD. f85 <i>_Form Collection</i>	<i>pag</i>	35
MOD. w07 <i>_Wood Collection</i>	<i>pag</i>	11	MOD. f86 <i>_Form Collection</i>	<i>pag</i>	36
MOD. w08 <i>_Wood Collection</i>	<i>pag</i>	12	MOD. f88 <i>_Form Collection</i>	<i>pag</i>	37
MOD. w09 <i>_Wood Collection</i>	<i>pag</i>	13	MOD. s51 <i>_Stone Collection</i>	<i>pag</i>	38
MOD. w11 <i>_Wood Collection</i>	<i>pag</i>	14	MOD. s53 <i>_Stone Collection</i>	<i>pag</i>	39
MOD. w12 <i>_Wood Collection</i>	<i>pag</i>	15	MOD. s54 <i>_Stone Collection</i>	<i>pag</i>	40
MOD. w15 <i>_Wood Collection</i>	<i>pag</i>	16	MOD. s55 <i>_Stone Collection</i>	<i>pag</i>	41
MOD. w16 <i>_Wood Collection</i>	<i>pag</i>	17	MOD. s56 <i>_Stone Collection</i>	<i>pag</i>	42
MOD. w74 <i>_Wood Collection</i>	<i>pag</i>	18	MOD. s57 <i>_Stone Collection</i>	<i>pag</i>	43
MOD. f21 <i>_Form Collection</i>	<i>pag</i>	20	MOD. s58 <i>_Stone Collection</i>	<i>pag</i>	44
MOD. f22 <i>_Form Collection</i>	<i>pag</i>	21	MOD. s70 <i>_Stone Collection</i>	<i>pag</i>	45
MOD. f23 <i>_Form Collection</i>	<i>pag</i>	22	MOD. s76 <i>_Stone Collection</i>	<i>pag</i>	46
MOD. f28 <i>_Form Collection</i>	<i>pag</i>	23	MOD. s80 <i>_Stone Collection</i>	<i>pag</i>	47
MOD. f29 <i>_Form Collection</i>	<i>pag</i>	24	MOD. s81 <i>_Stone Collection</i>	<i>pag</i>	48
MOD. f30 <i>_Form Collection</i>	<i>pag</i>	25	MOD. s82 <i>_Stone Collection</i>	<i>pag</i>	49
MOD. f31 <i>_Form Collection</i>	<i>pag</i>	26	MOD. s83 <i>_Stone Collection</i>	<i>pag</i>	50
MOD. f34 <i>_Form Collection</i>	<i>pag</i>	27	MOD. s84 <i>_Stone Collection</i>	<i>pag</i>	51
MOD. f35 <i>_Form Collection</i>	<i>pag</i>	28	MOD. s87 <i>_Stone Collection</i>	<i>pag</i>	52
MOD. f36 <i>_Form Collection</i>	<i>pag</i>	29	MOD. L00	<i>pag</i>	53

Linea matrici *ALTORILIEVO*

54

MOD. 04E	<i>pag</i>	55	MOD. 16E	<i>pag</i>	60
MOD. 05E	<i>pag</i>	55	MOD. 24E	<i>pag</i>	60
MOD. 06E	<i>pag</i>	56	MOD. 30E	<i>pag</i>	61
MOD. 08E	<i>pag</i>	56	MOD. 31E	<i>pag</i>	61
MOD. 09E	<i>pag</i>	57	MOD. 62E	<i>pag</i>	62
MOD. 10E	<i>pag</i>	57	MOD. 67E	<i>pag</i>	62
MOD. 11E	<i>pag</i>	58	MOD. 69E	<i>pag</i>	63
MOD. 13E	<i>pag</i>	58	MOD. 70E	<i>pag</i>	63
MOD. 14E	<i>pag</i>	59	MOD. 71E	<i>pag</i>	65
MOD. 15E	<i>pag</i>	59	MOD. 80E	<i>pag</i>	65

E' il momento della massima resa,
della praticità e della differenza.
Tutto con estrema facilità!

BETON·UNO™

Linea matrici STANDARD.

Linea di matrici mono-getto dai rilievi poco accentuati, disponibili in una quarantina di disegni, abbelliscono il calcestruzzo in modo semplice ed economico. Adatte per tutti i tipi di calcestruzzo, anche auto-compattanti, sono garantite per minimo un getto. Posa facile e veloce sui casseri tramite chiodi o con l'apposito adesivo, non necessitano disarmante e quindi i muri possono venire eventualmente tinteggiati immediatamente dopo il disarmo.

Le finiture della serie STANDARD conferiscono al calcestruzzo gettato superfici discrete ed eleganti o, a vostra scelta, dei disegni più pronunciati.

Le misure sono espresse in mm.

MOD. w01

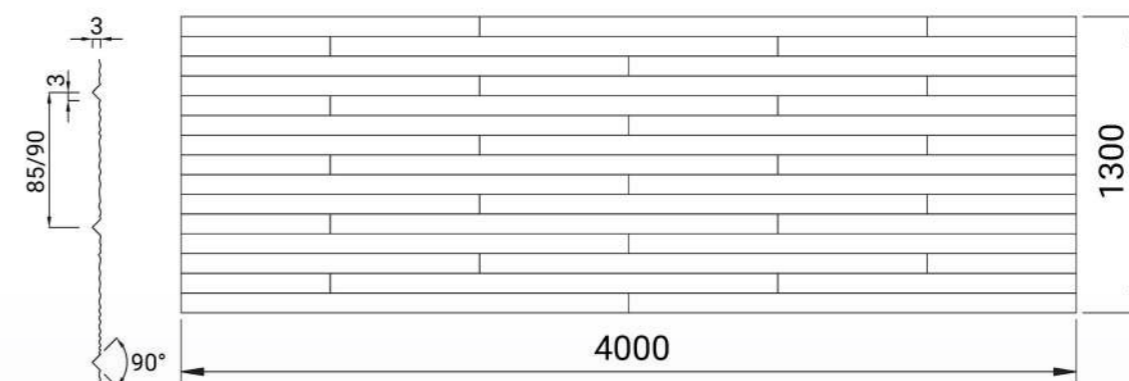

Dettaglio del getto



Wood collection

MOD. W02

MOD. W03

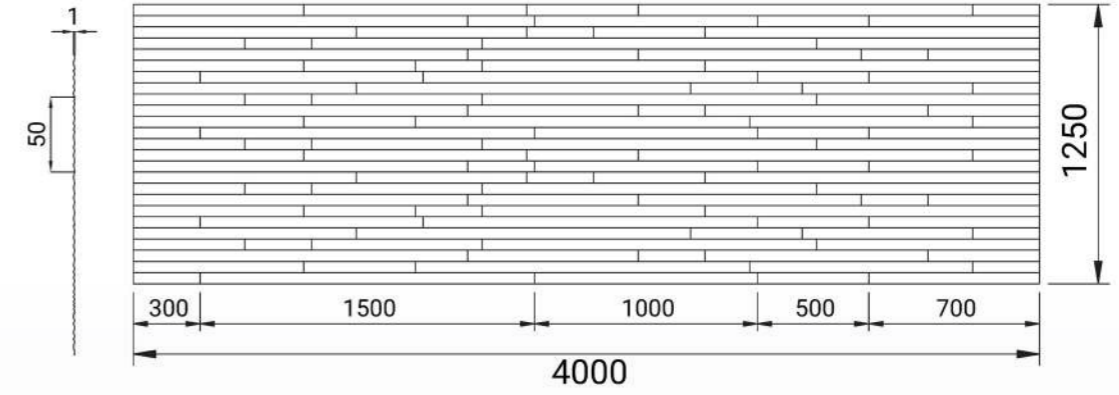
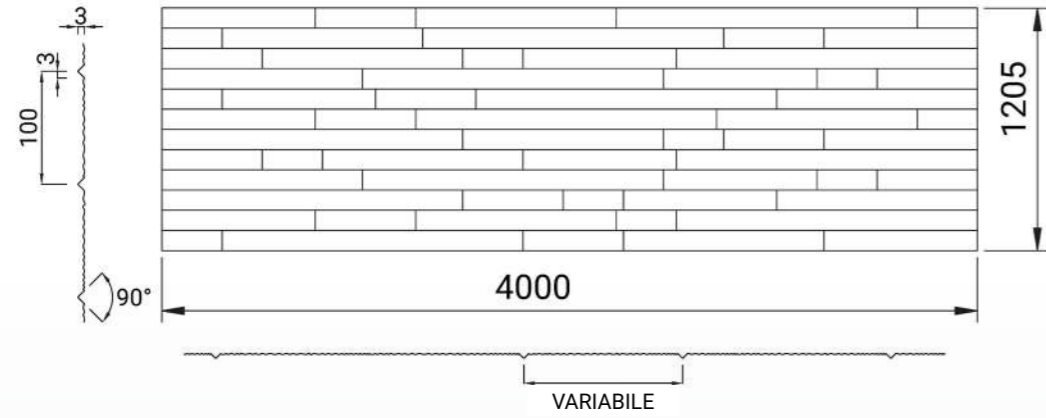

Dettaglio del getto

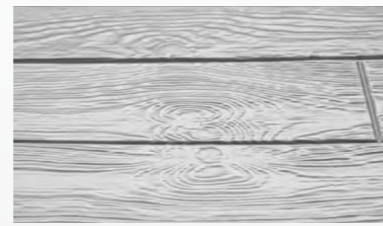

Dettaglio del getto

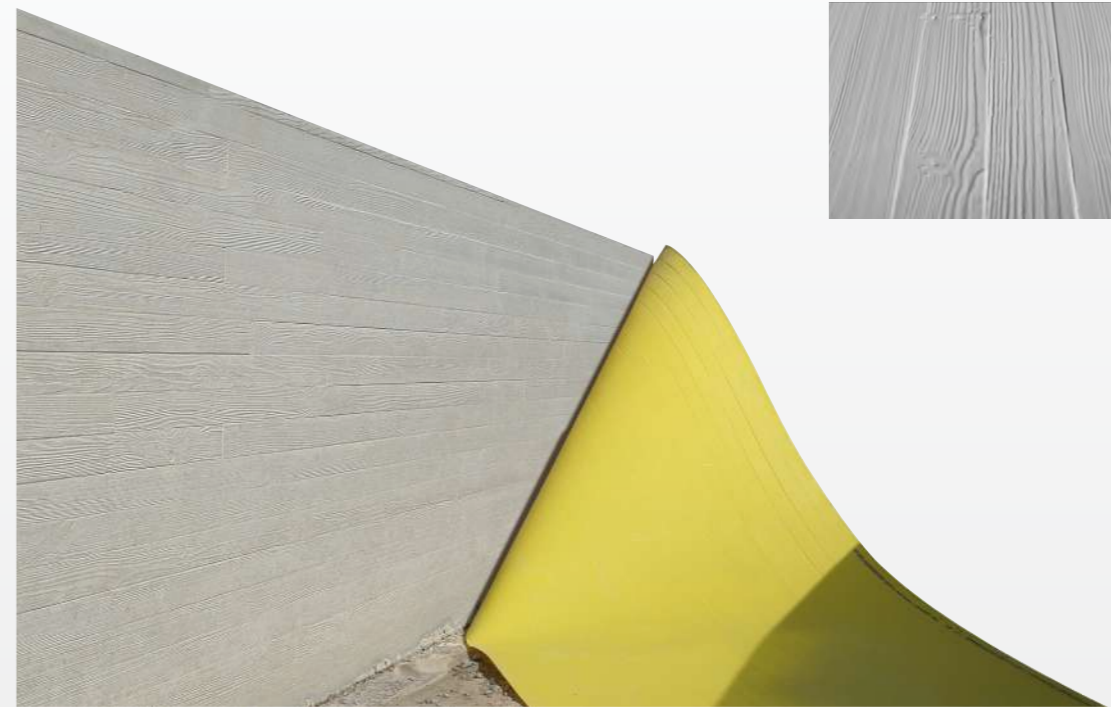
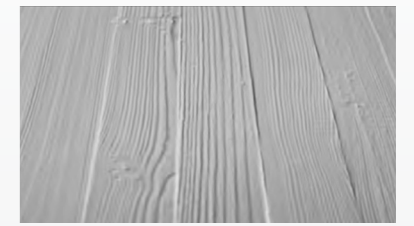

Wood collection

Wood collection

MOD. w04

MOD. w05

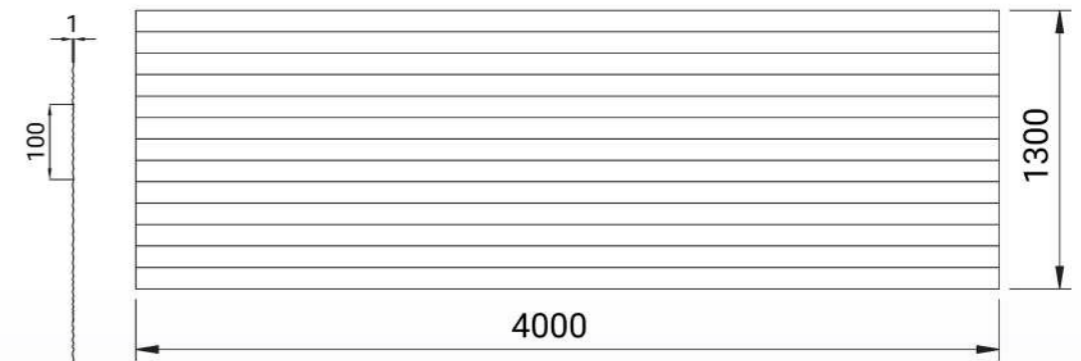
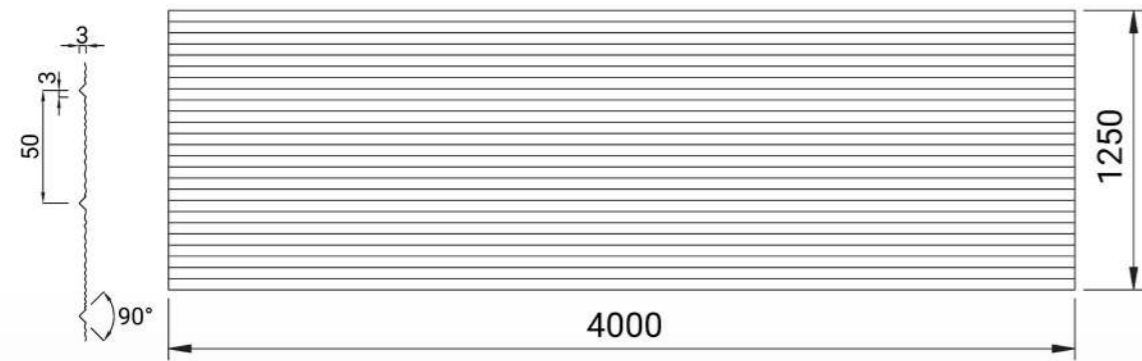

Dettaglio del getto

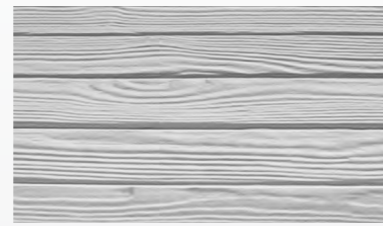

Dettaglio del getto

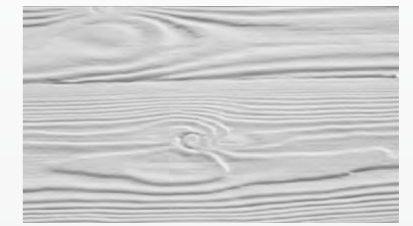

Wood collection

Wood collection

MOD. w06

MOD. w07

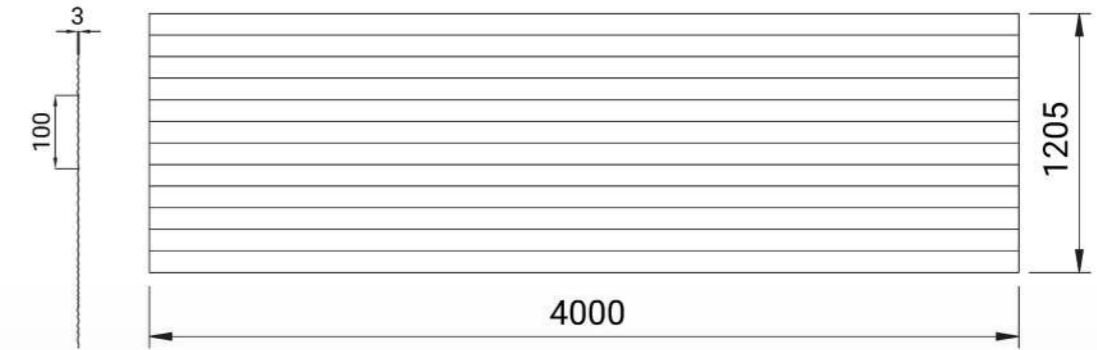
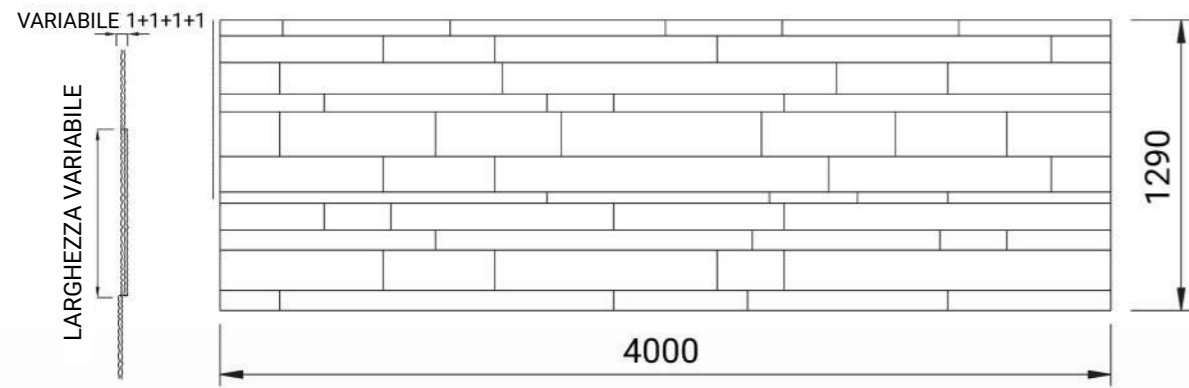

Dettaglio del getto

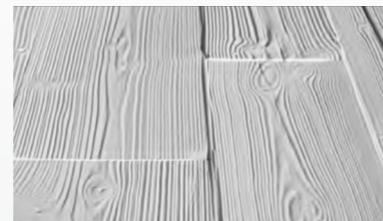

Dettaglio del getto

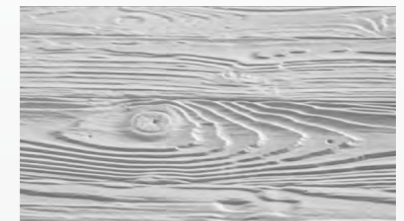

Wood collection

Wood collection

MOD. W08

MOD. W09

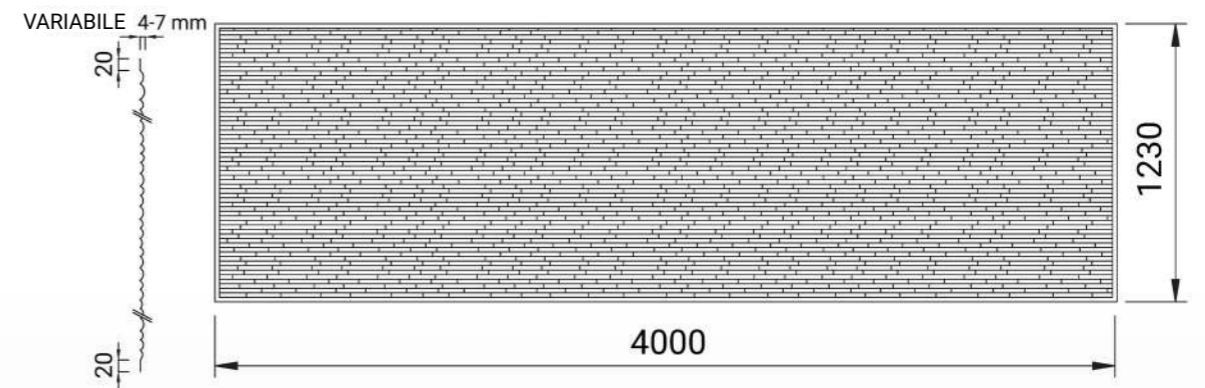
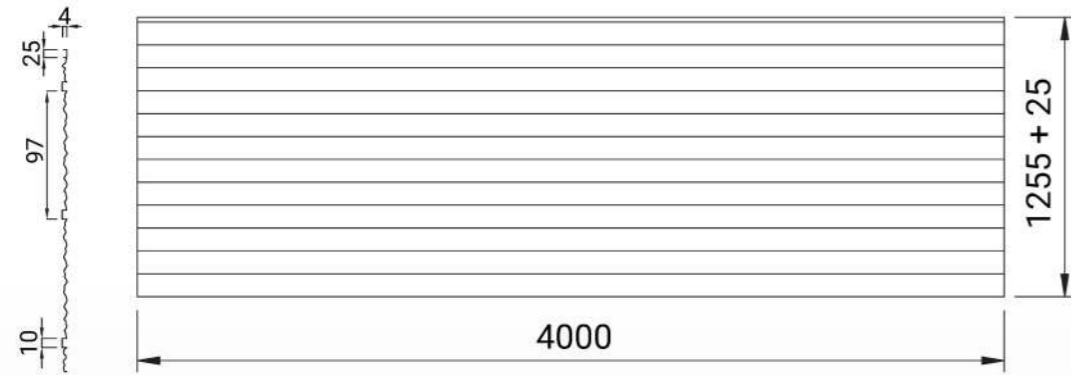

Dettaglio del getto

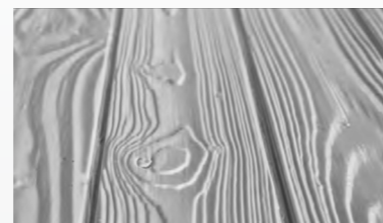

Dettaglio del getto

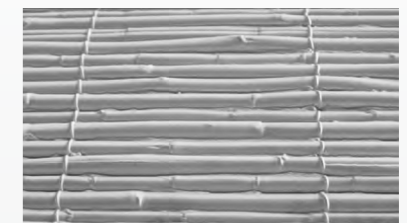

Wood collection

Wood collection

MOD. W11

MOD. W12

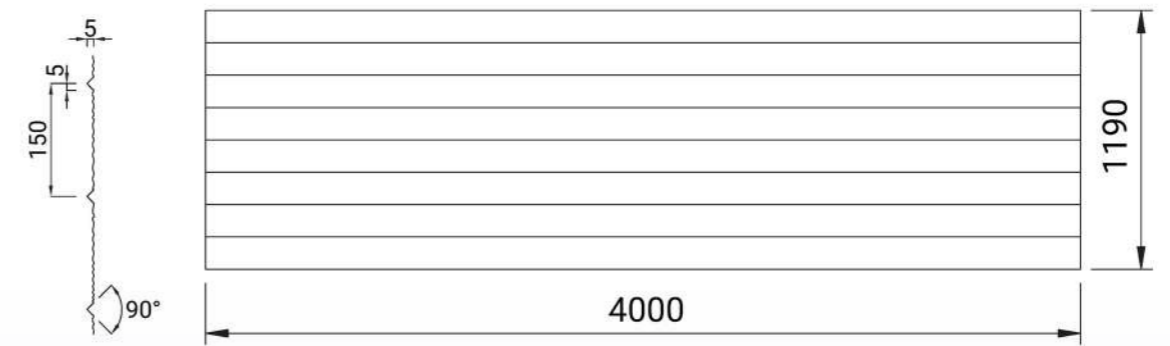
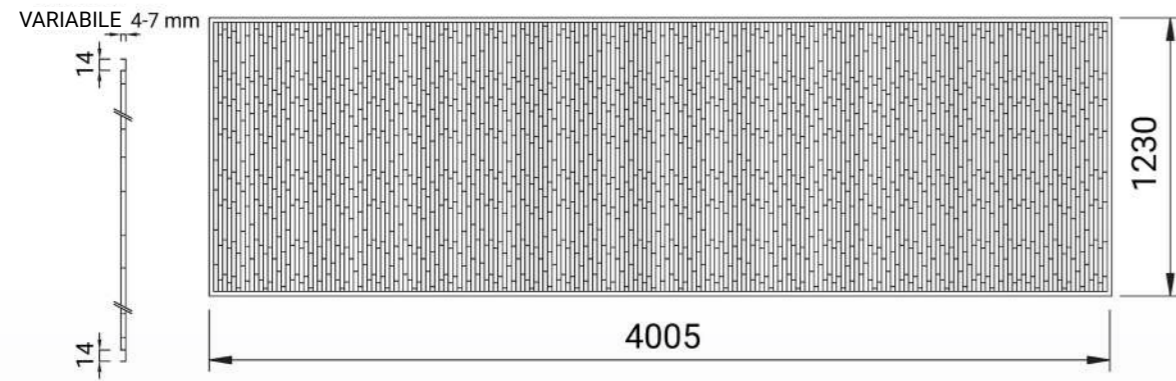

Dettaglio del getto

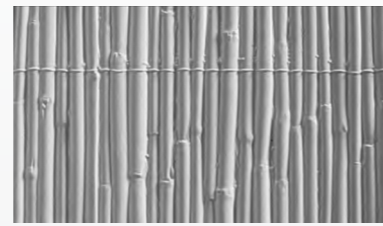

Dettaglio del getto

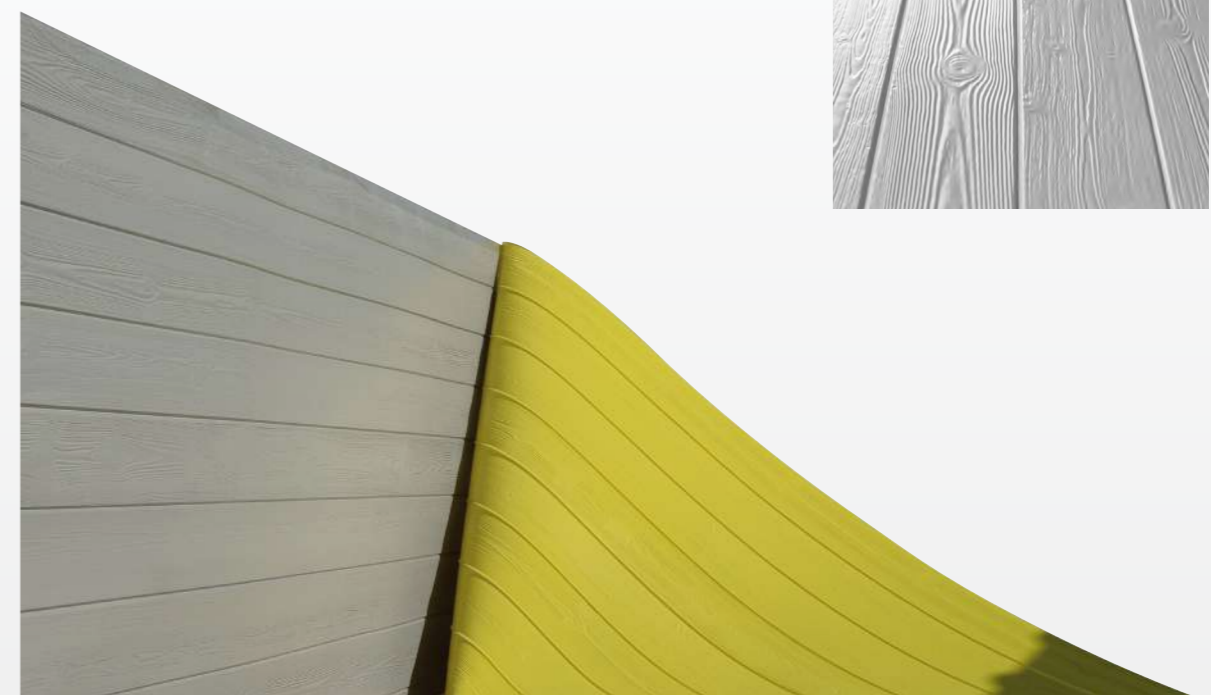
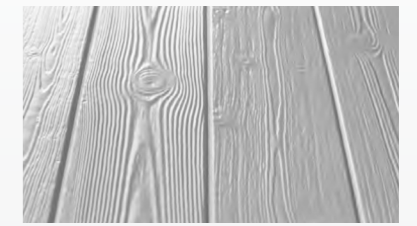

Wood collection

Wood collection

MOD. w15

MOD. w16

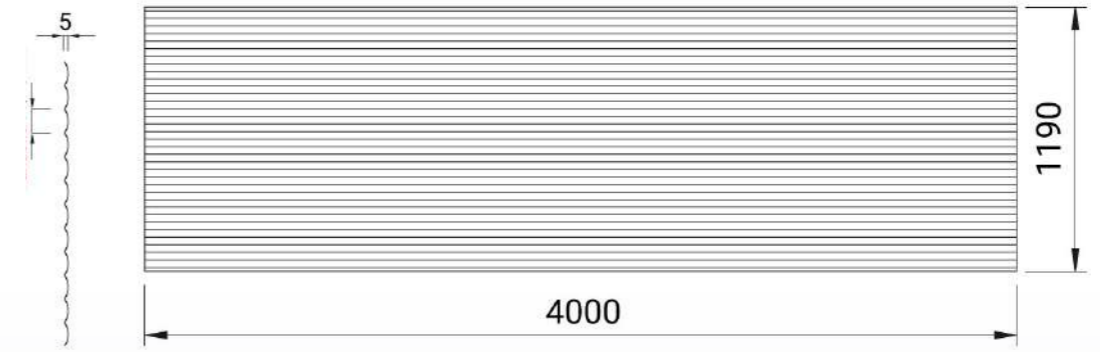
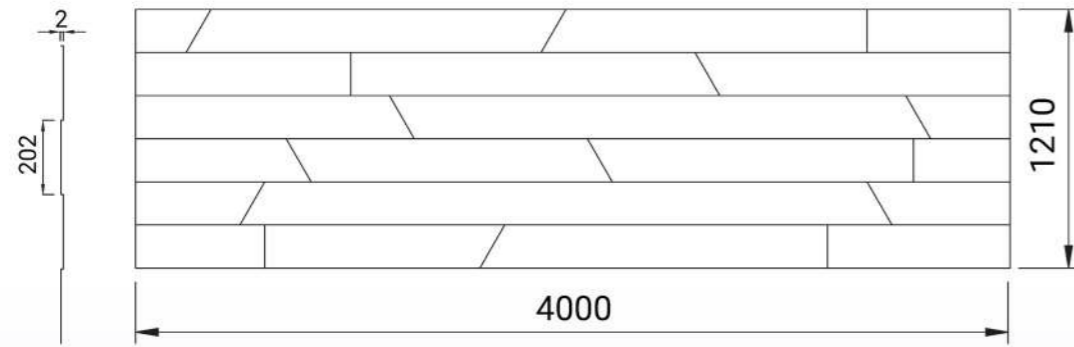

Dettaglio del getto



Dettaglio del getto



Wood collection

Wood collection

MOD. w74

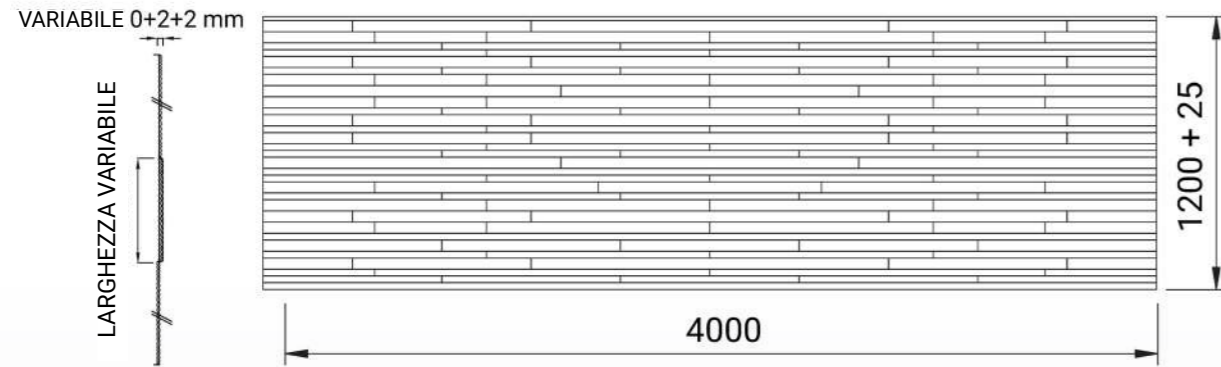

Dettaglio del getto

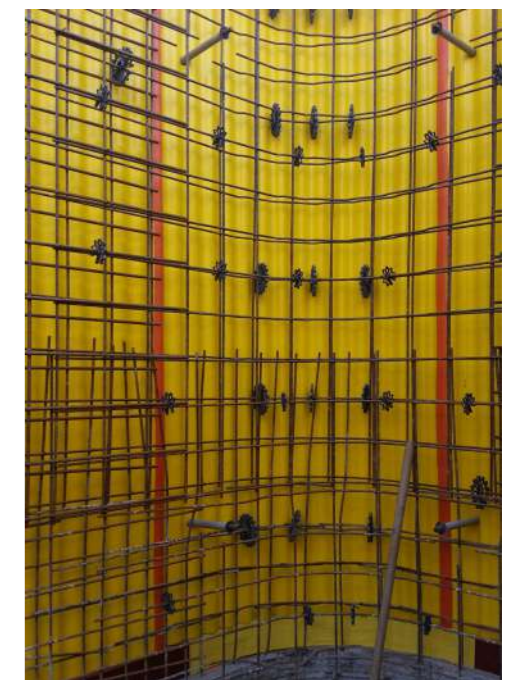
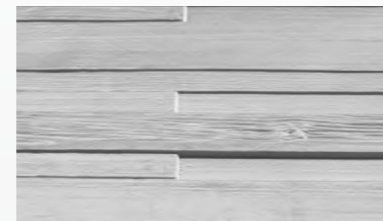

Wood collection

MOD. F21

MOD. F22

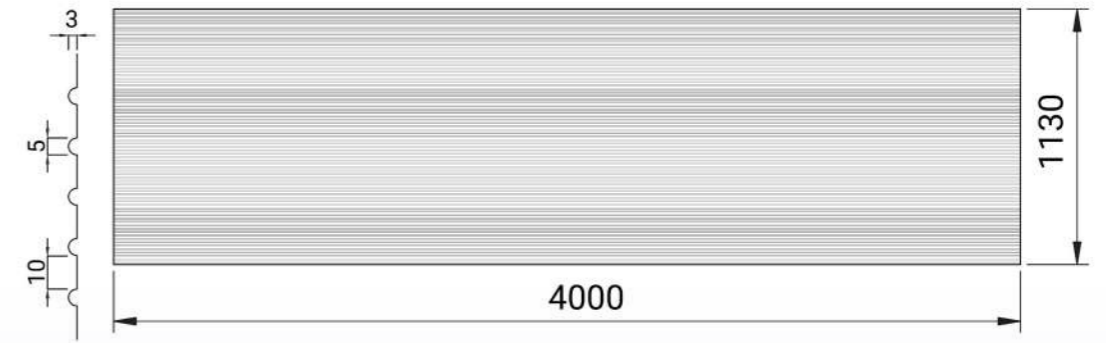
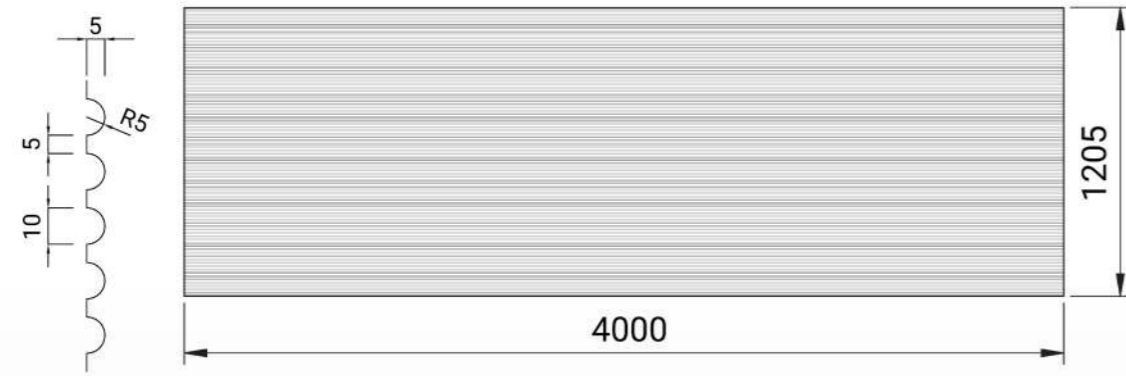

Dettaglio del getto

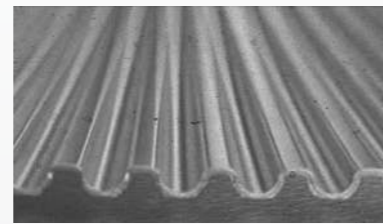

Dettaglio del getto

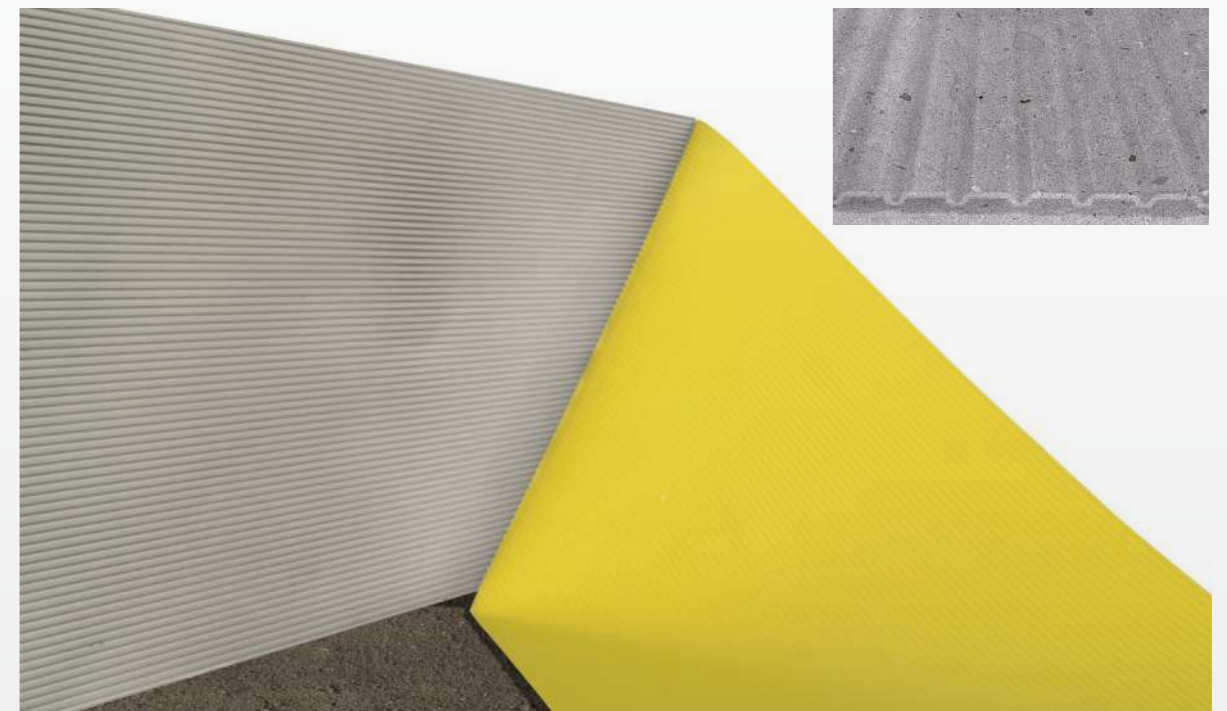
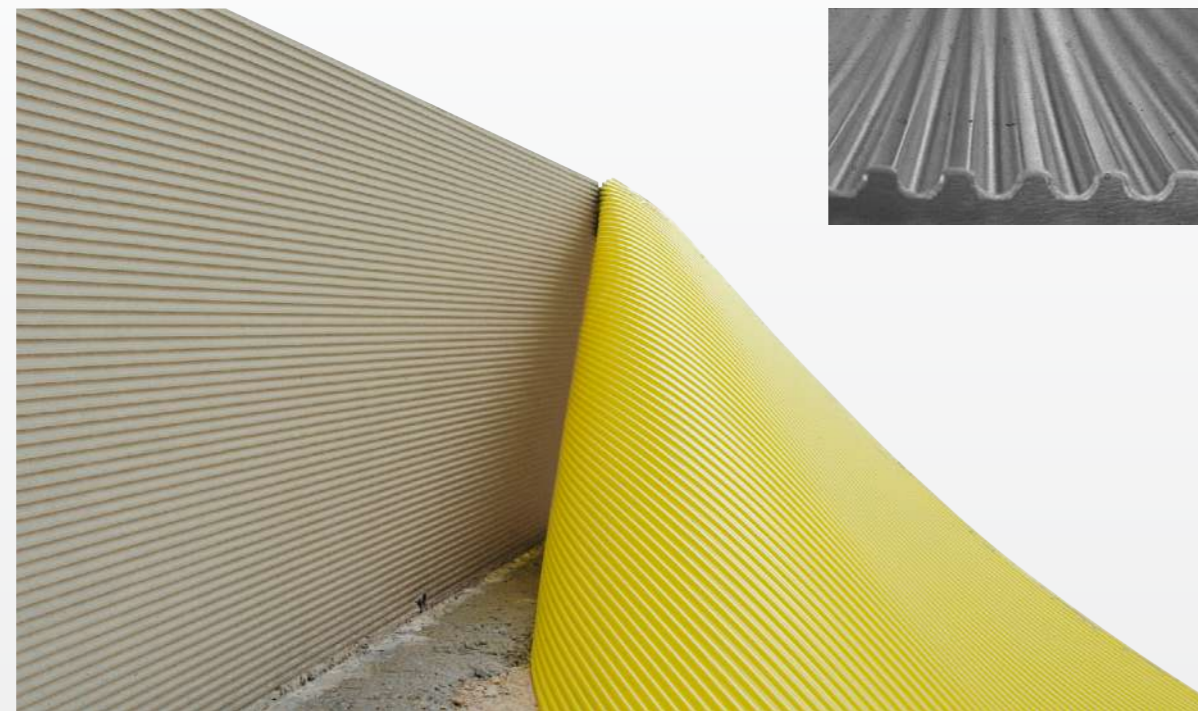
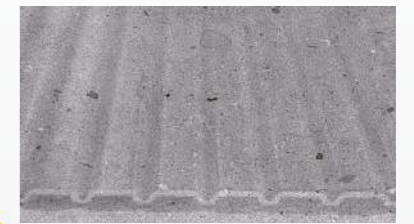

Form collection

Form collection

MOD. F23

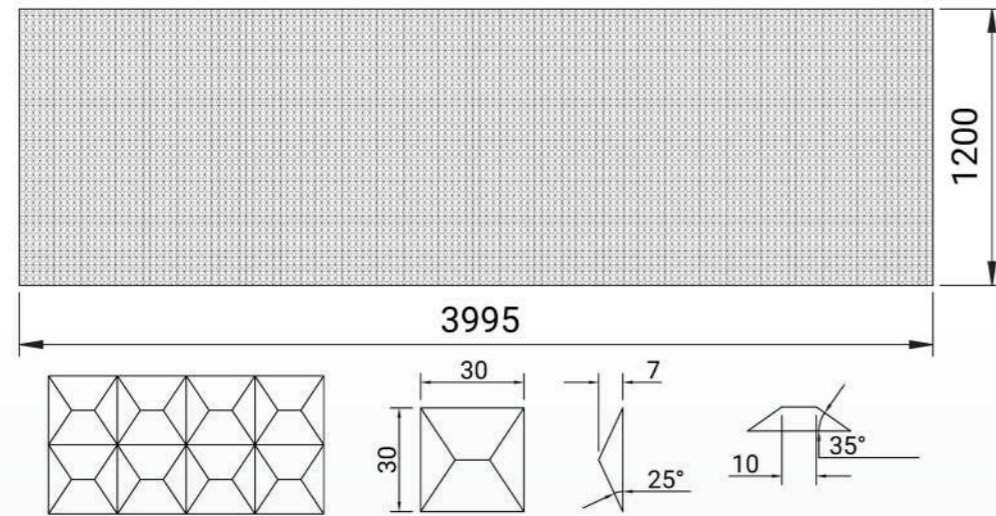

Dettaglio del getto

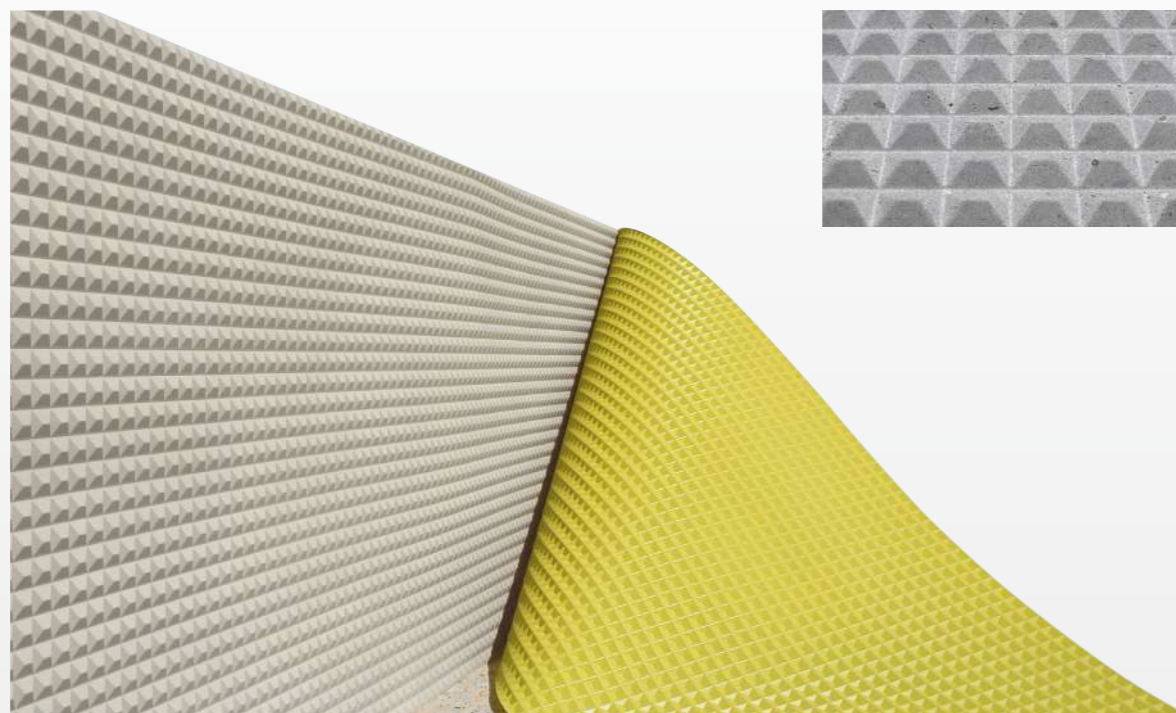
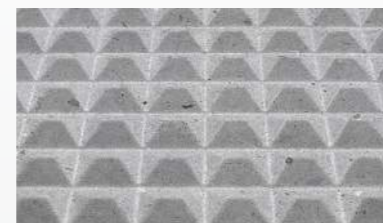

Form collection

MOD. F28

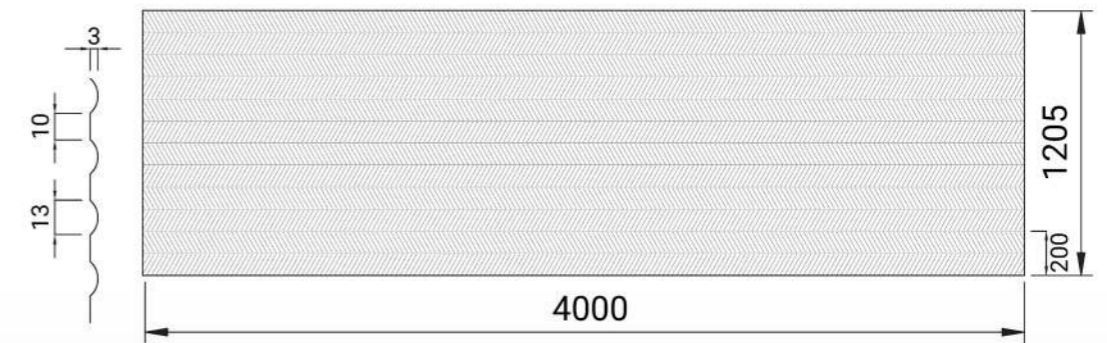

Dettaglio del getto



Form collection

MOD. F29

MOD. F30

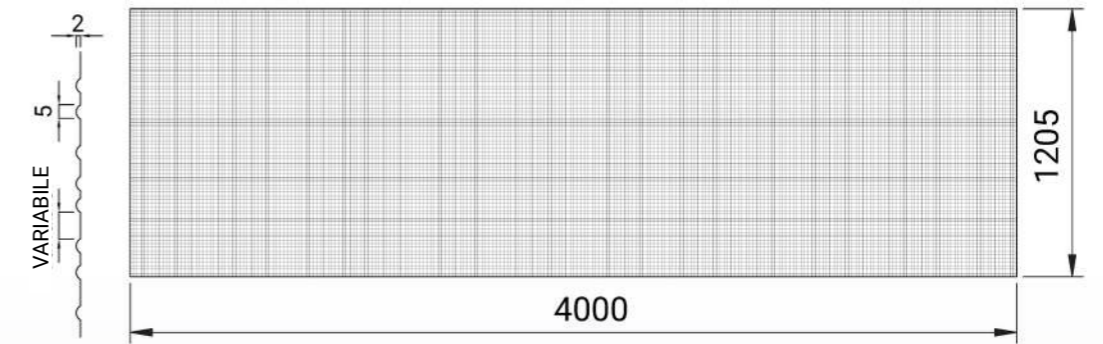
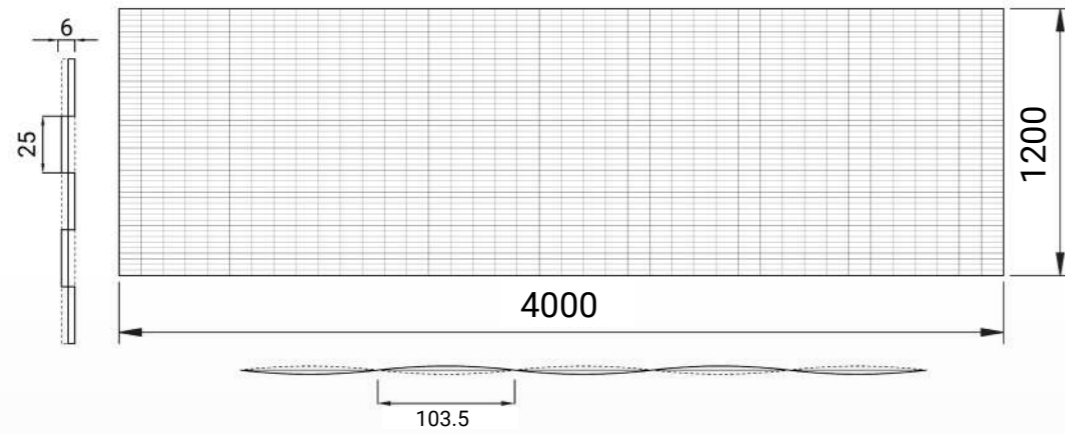

Dettaglio del getto

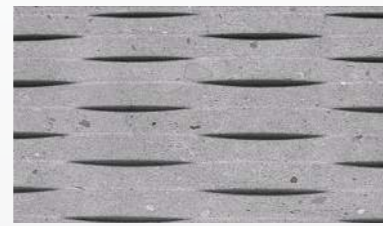

Dettaglio del getto

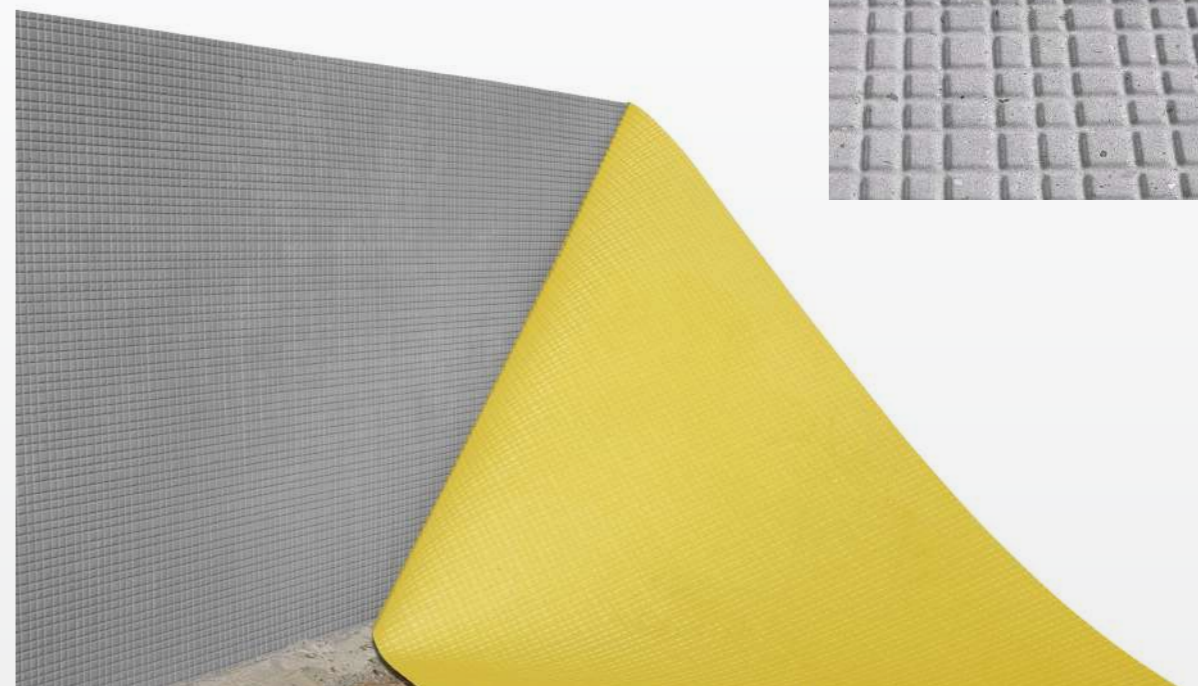

Form collection

Form collection

MOD. F31

MOD. F34

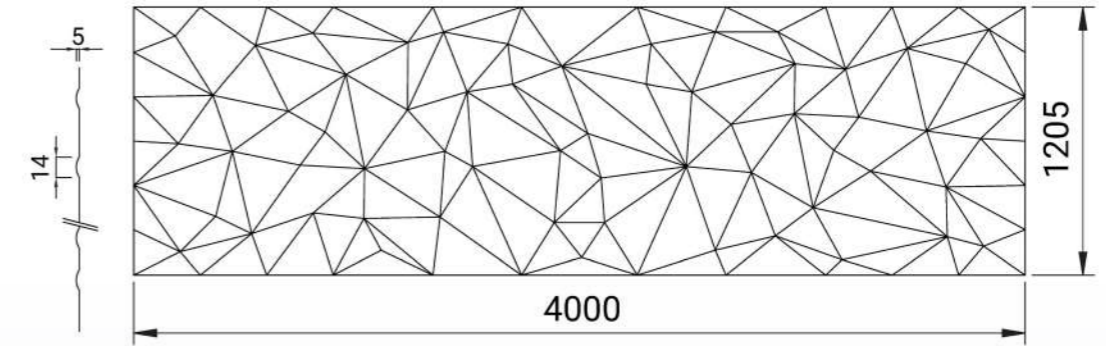
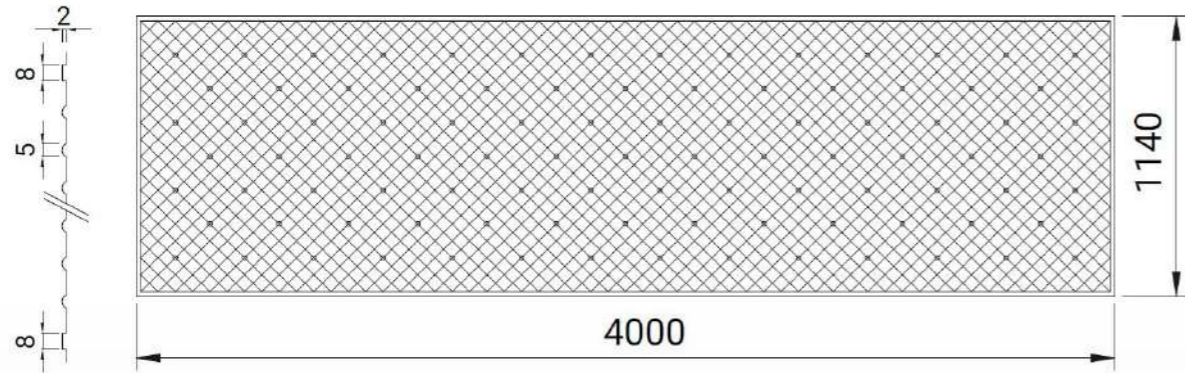

Dettaglio del getto



Dettaglio del getto

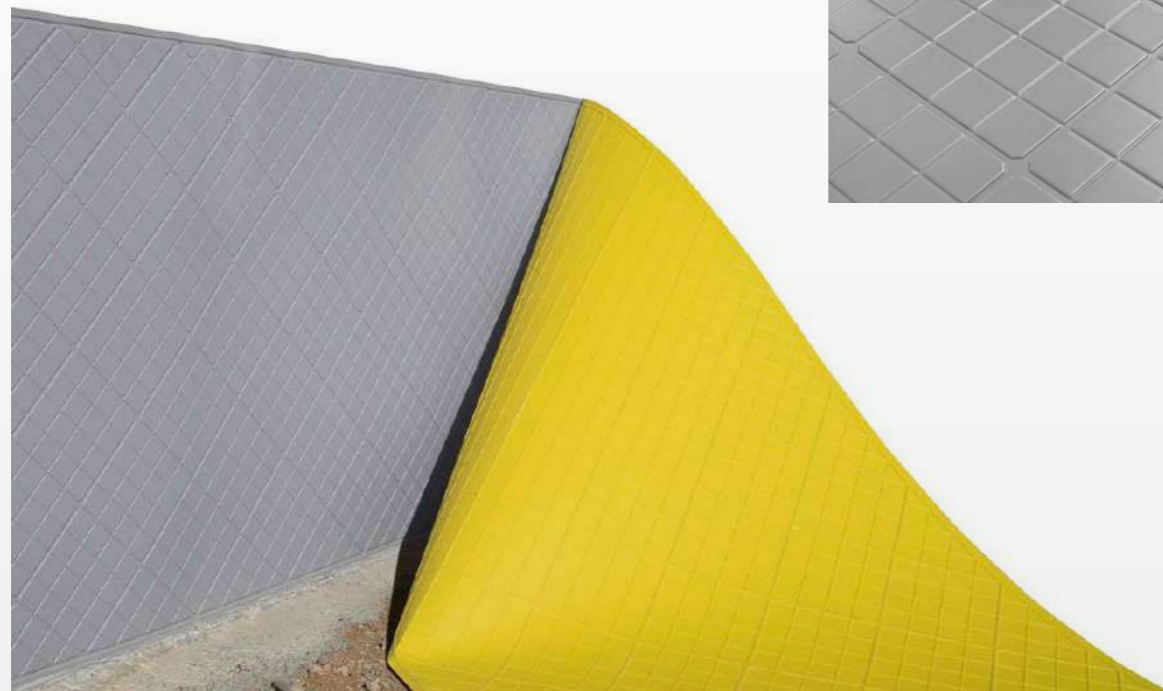
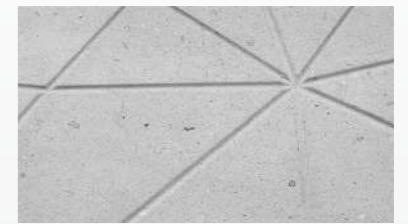

Form collection

Form collection

MOD. F35

MOD. F36

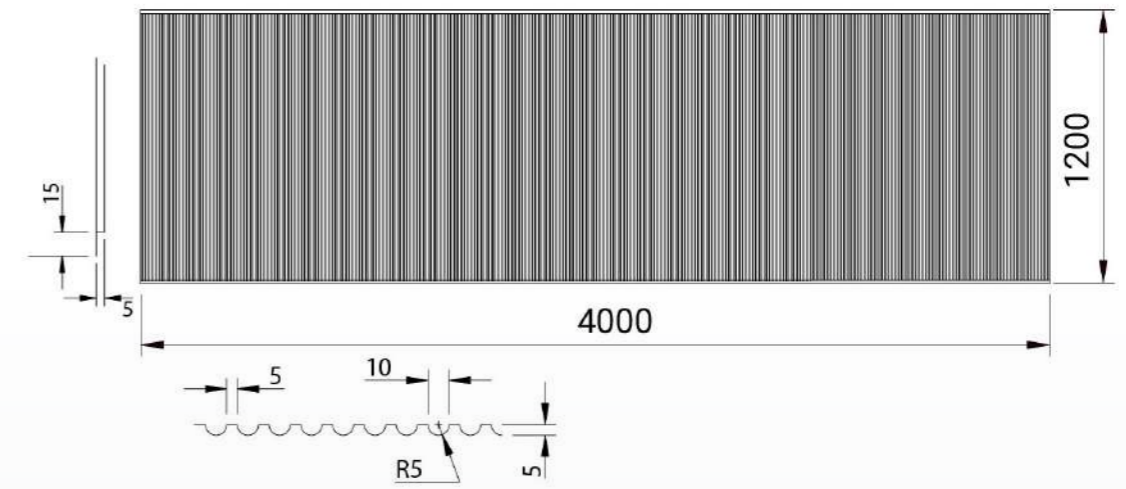
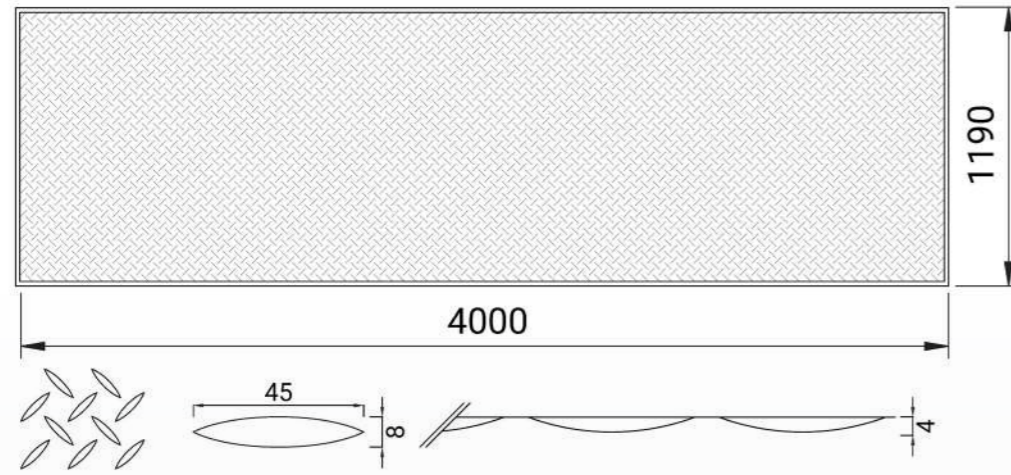

Dettaglio del getto



Dettaglio del getto

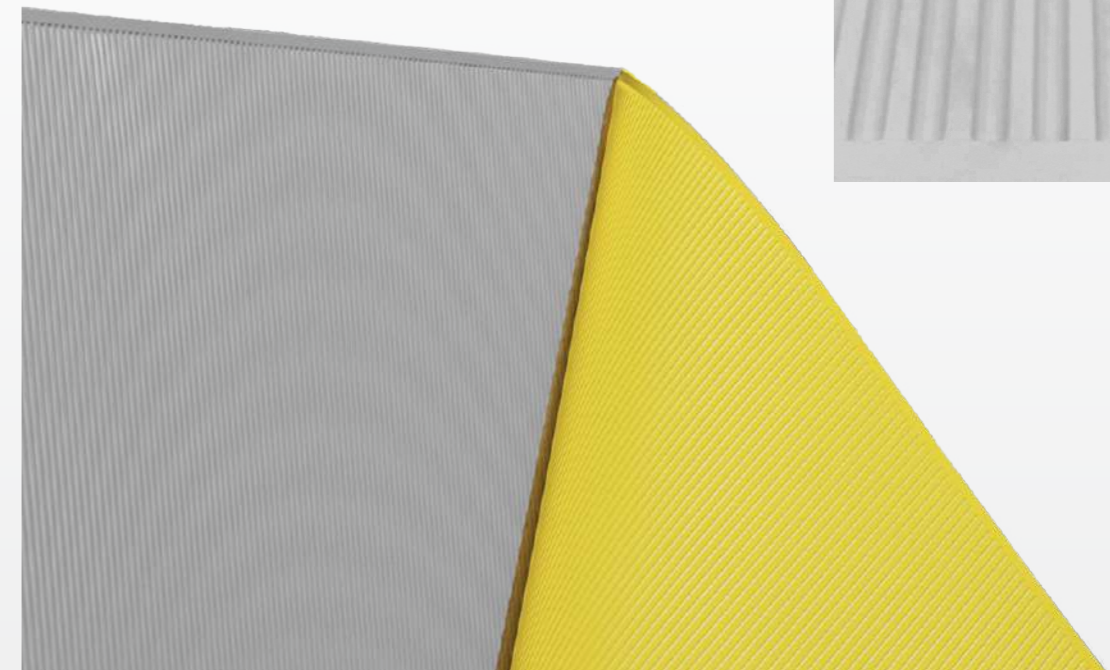
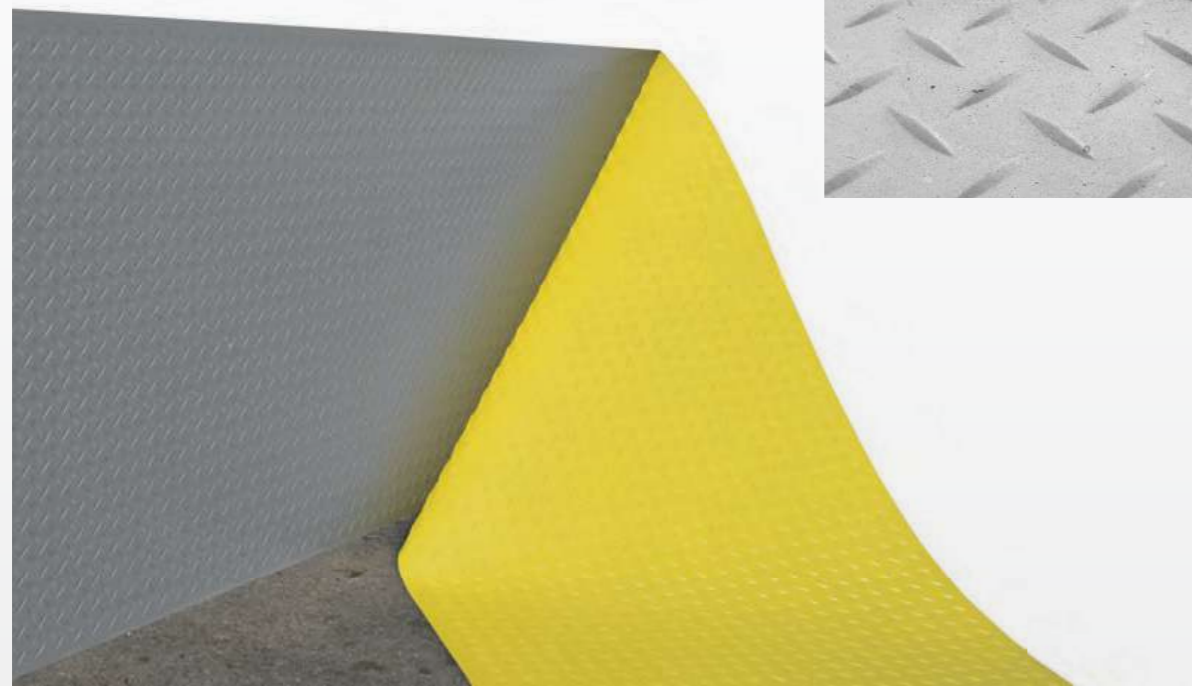
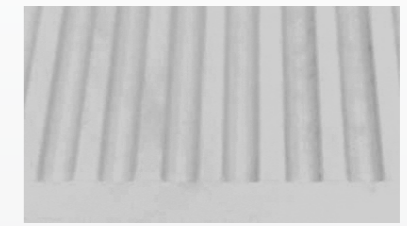

Form collection

Form collection

MOD. F37

MOD. F61

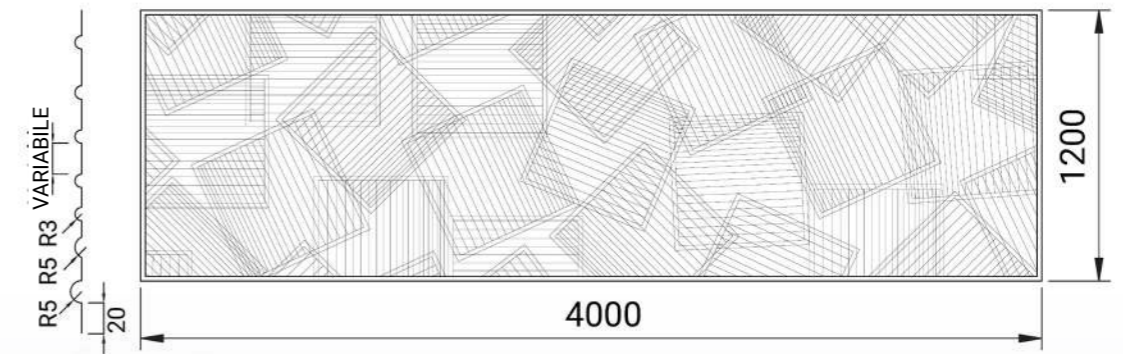
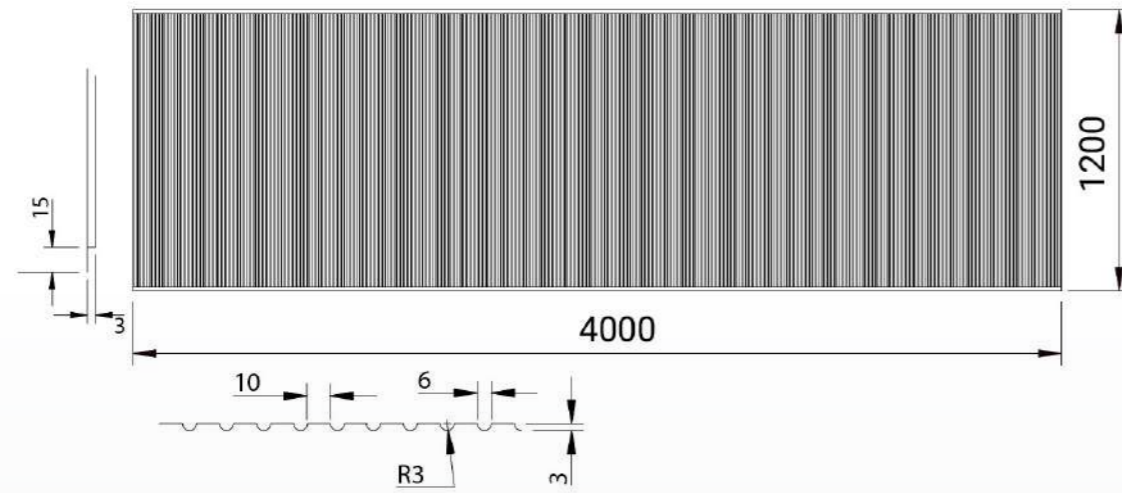

Dettaglio del getto

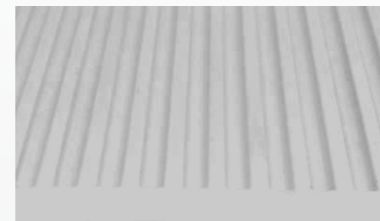

Dettaglio del getto

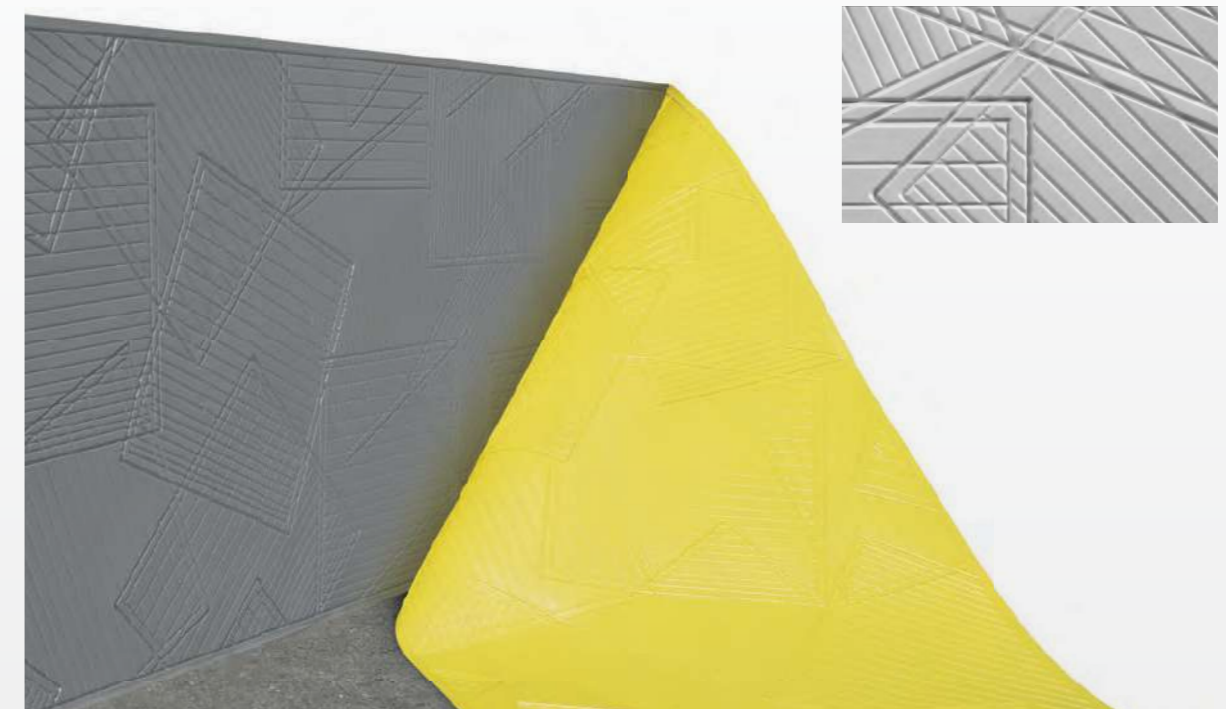
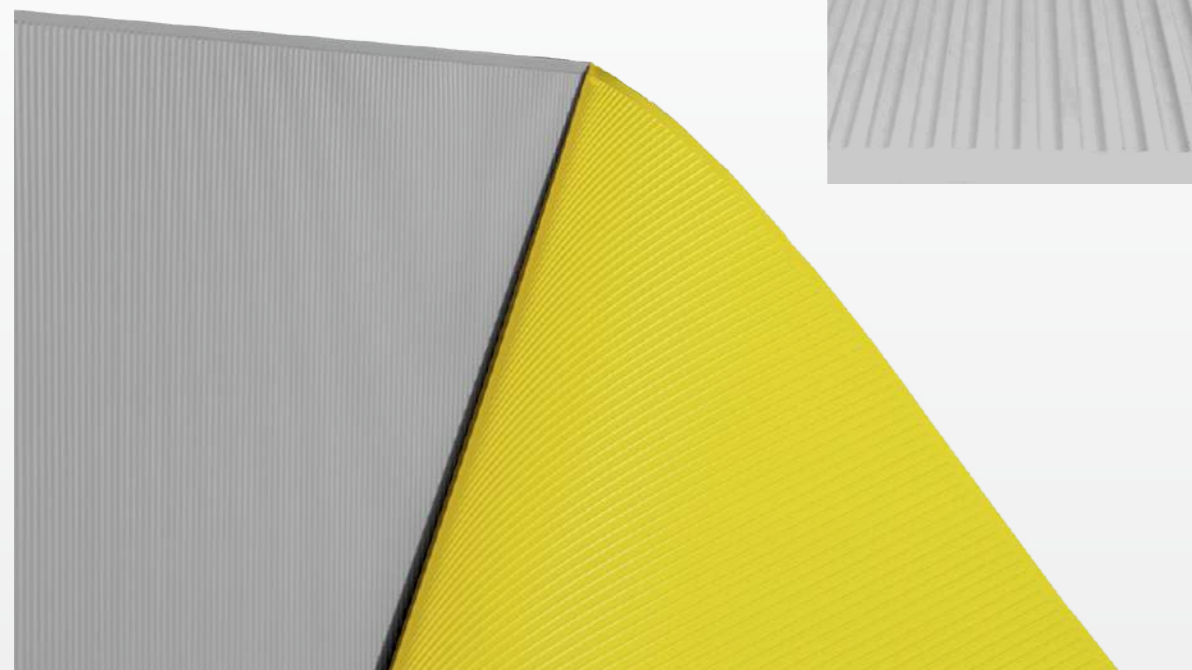

Form collection

Form collection

MOD. F66

MOD. F75

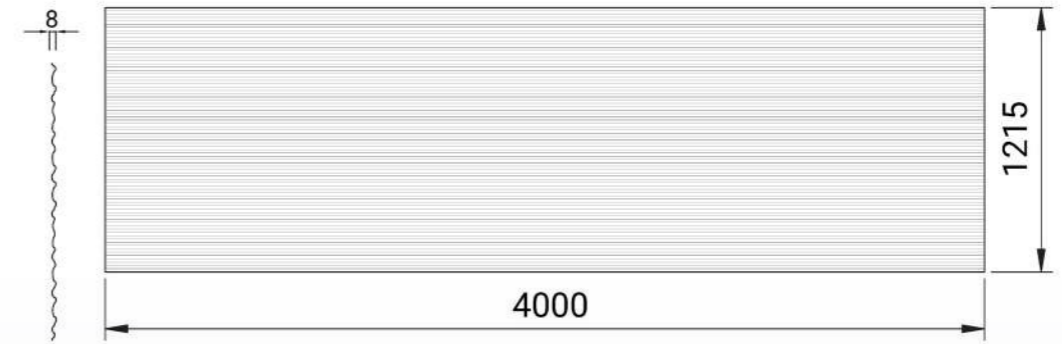
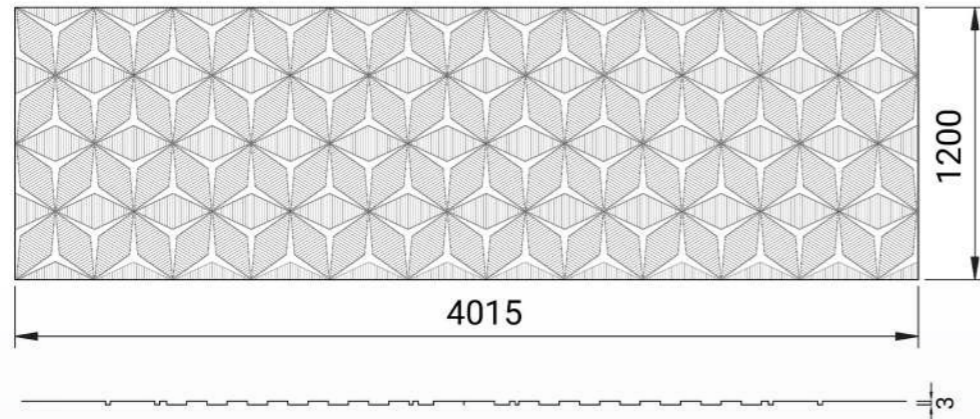

Dettaglio del getto



Dettaglio del getto

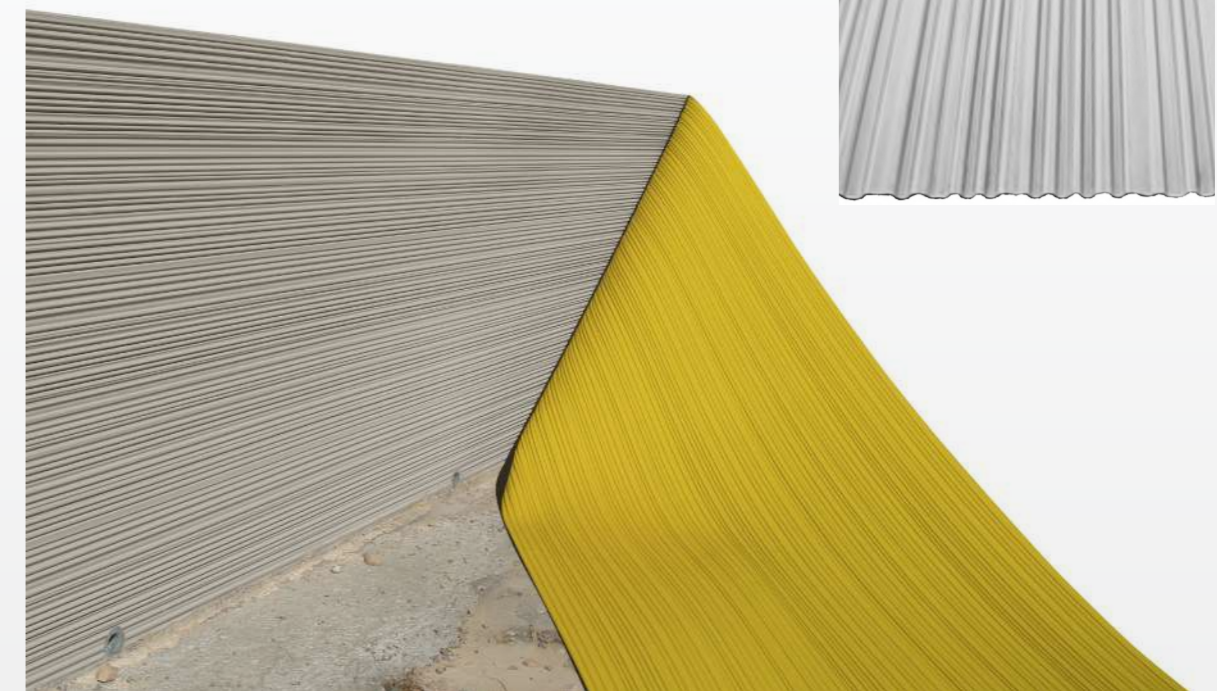
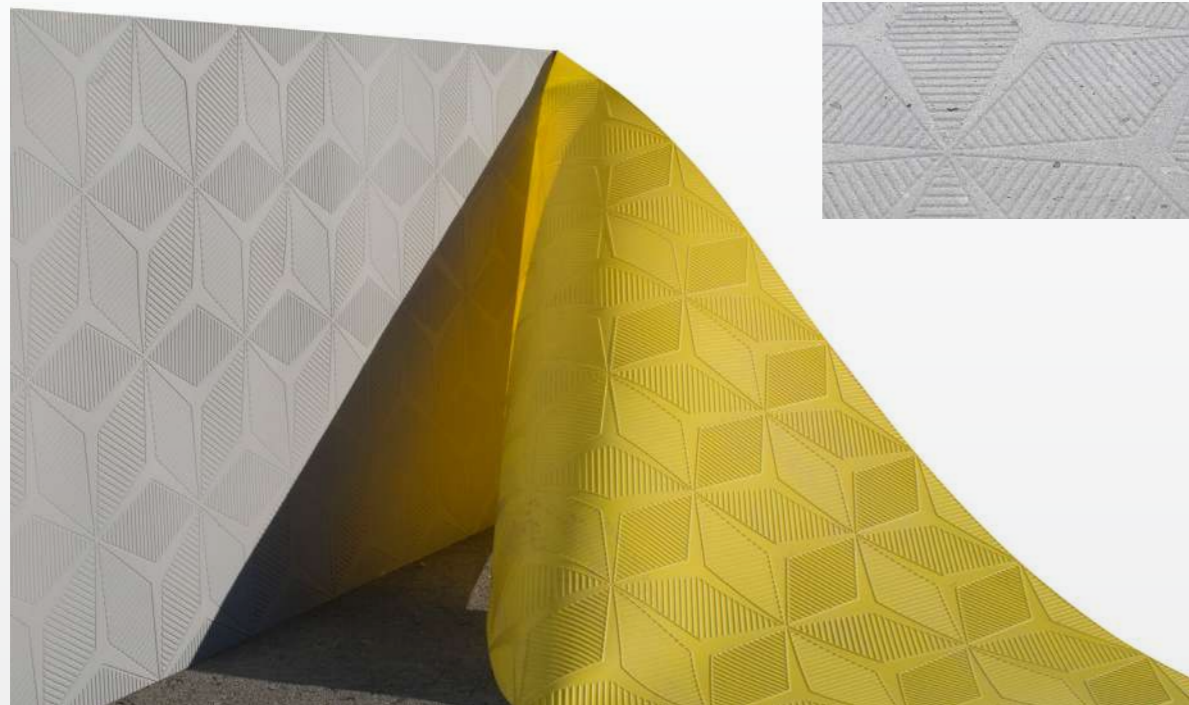

Form collection

Form collection

MOD. F77

MOD. F85

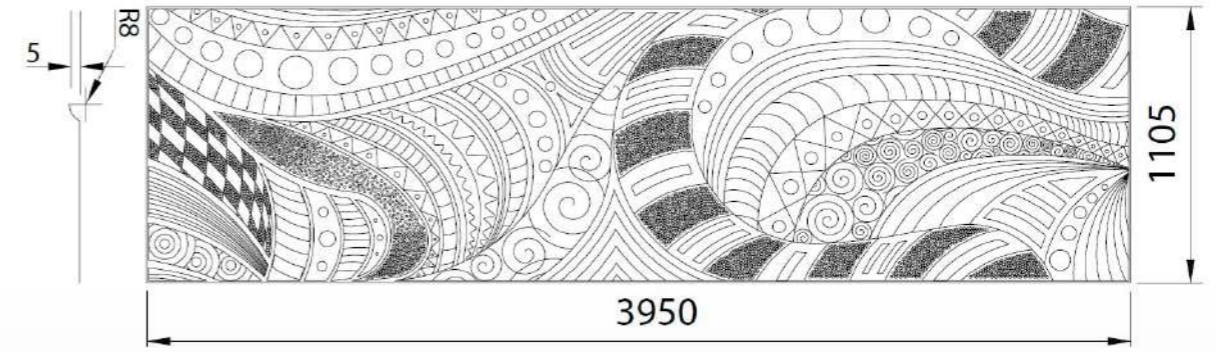
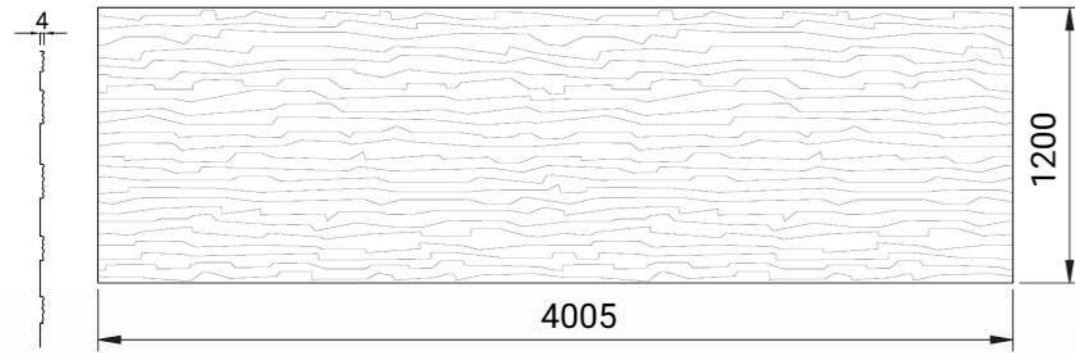

Dettaglio del getto



Dettaglio del getto

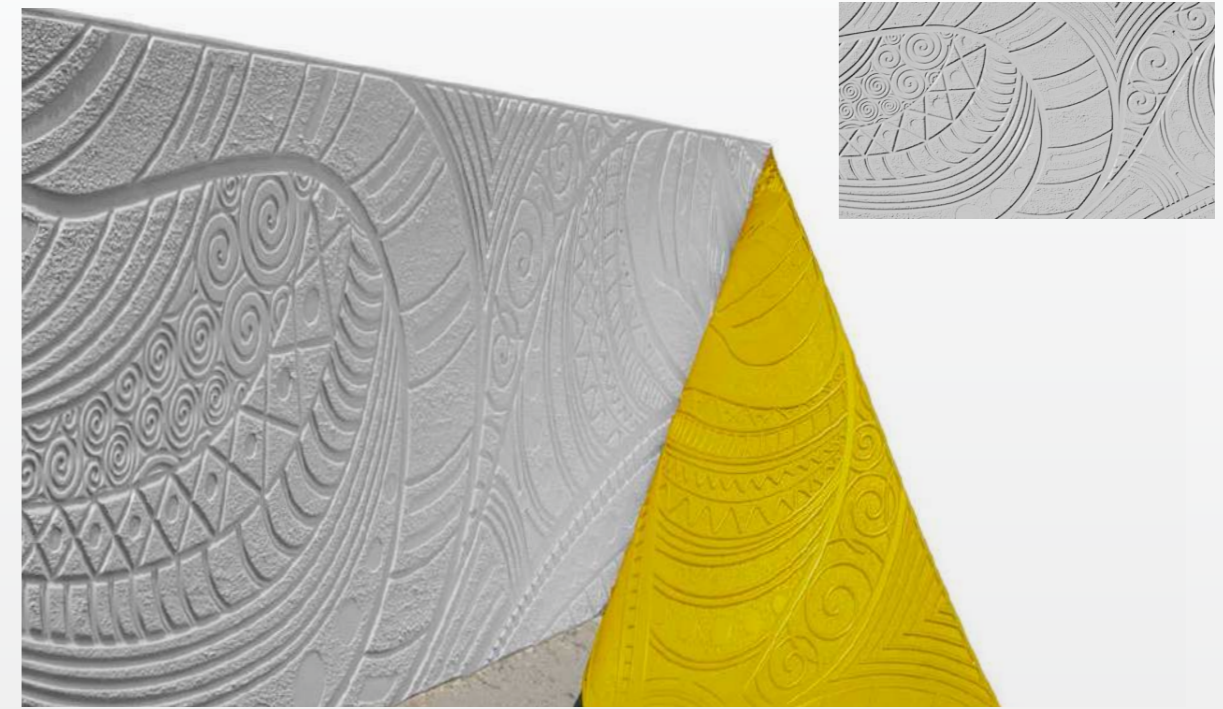
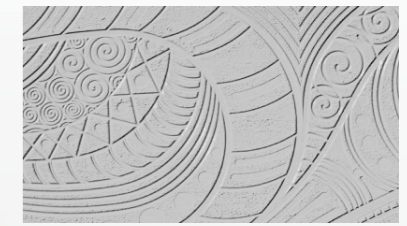

Form collection

Form collection

MOD. F86

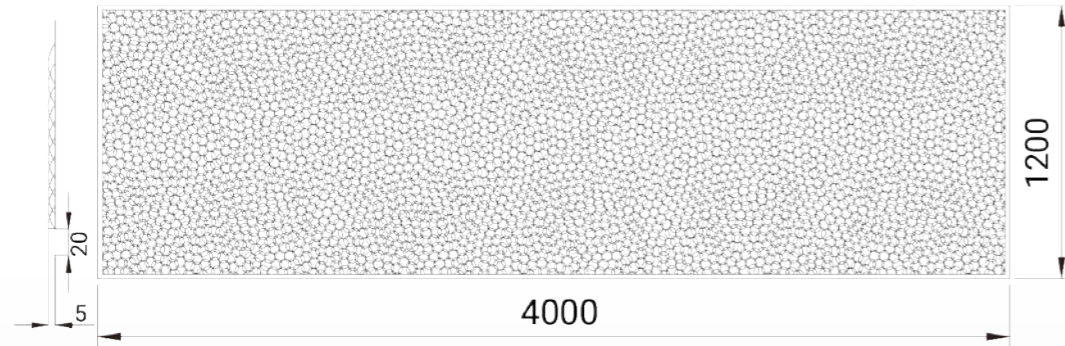

Dettaglio del getto

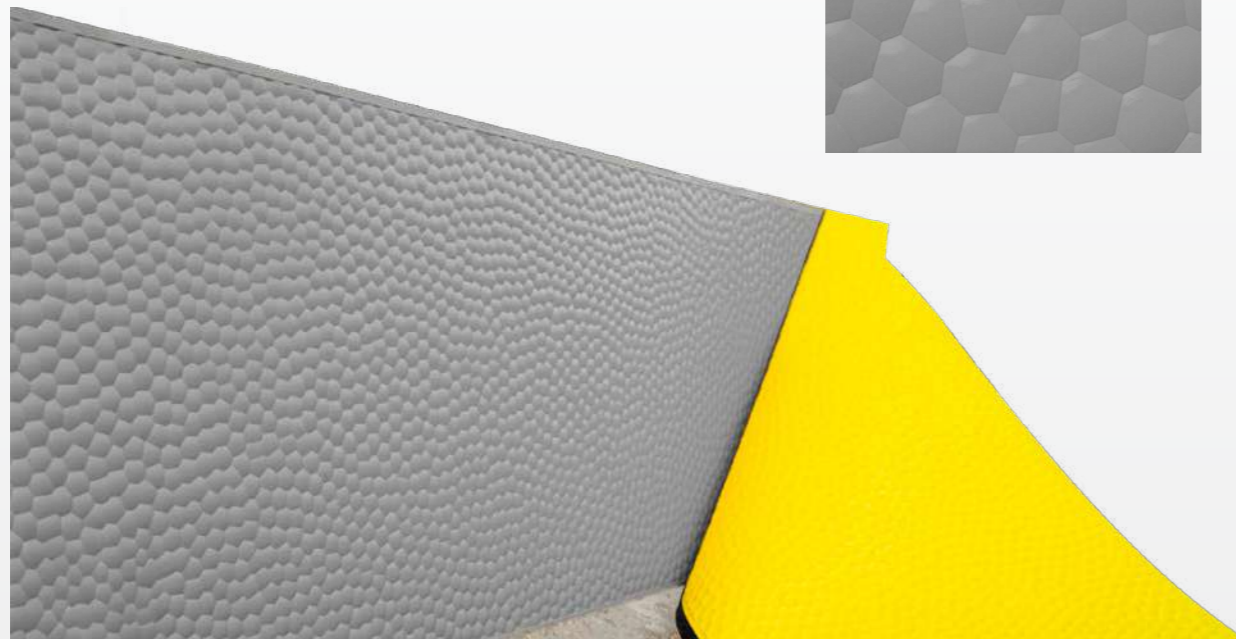
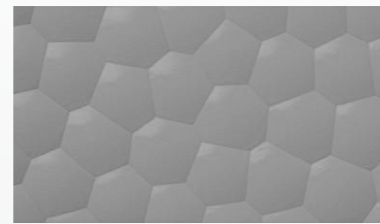

Form collection

MOD. F88

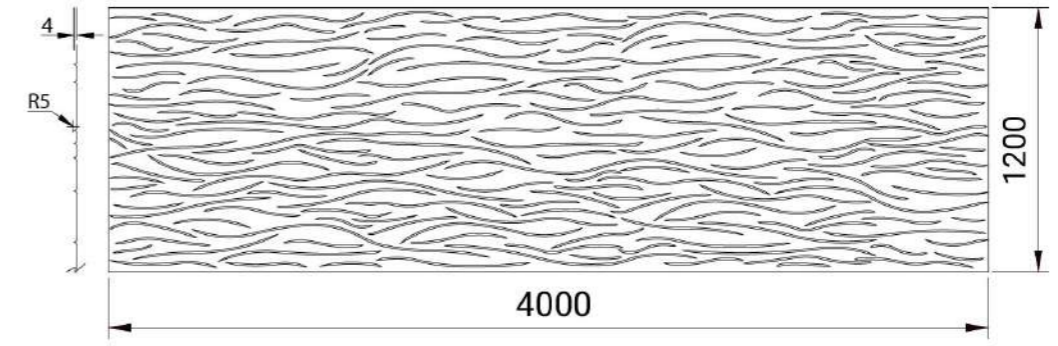

Dettaglio del getto

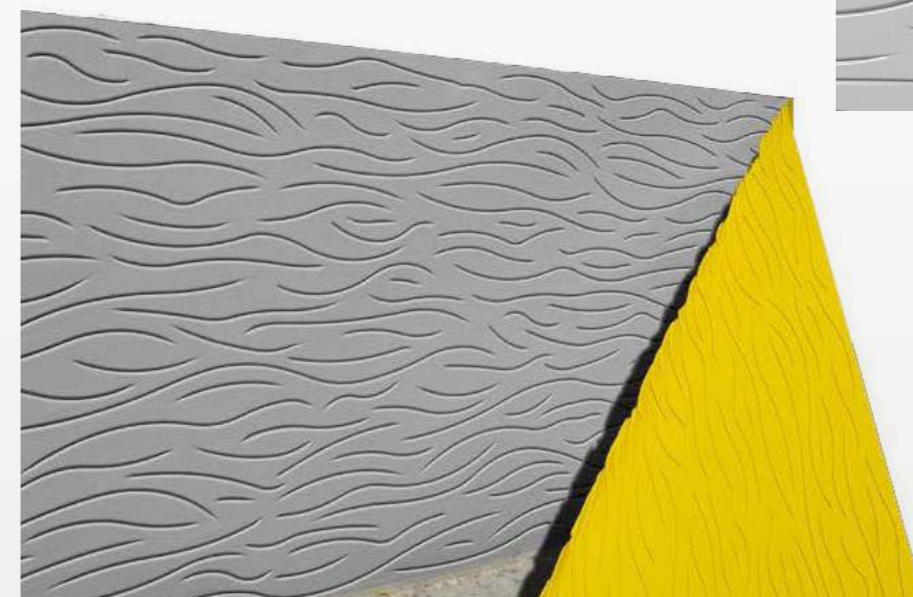
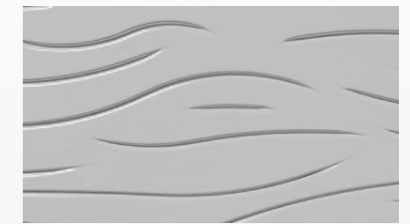

Form collection

MOD. s51

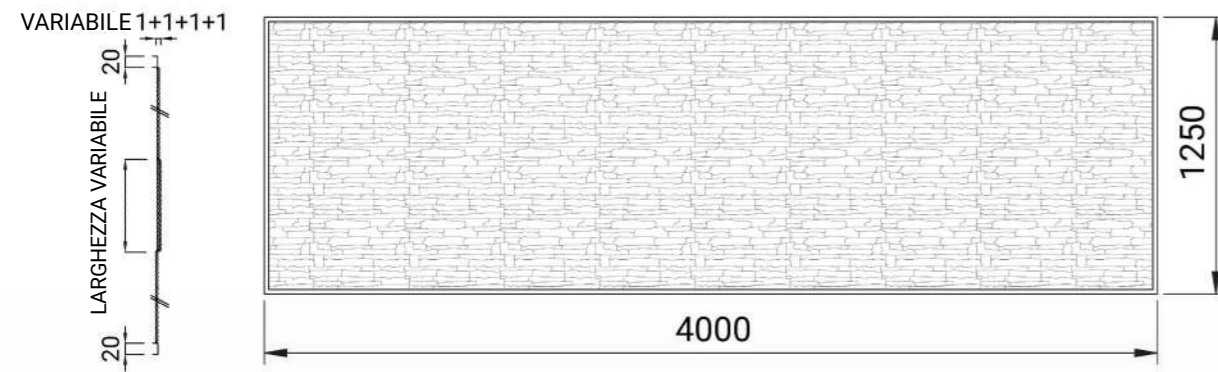

MOD. s53

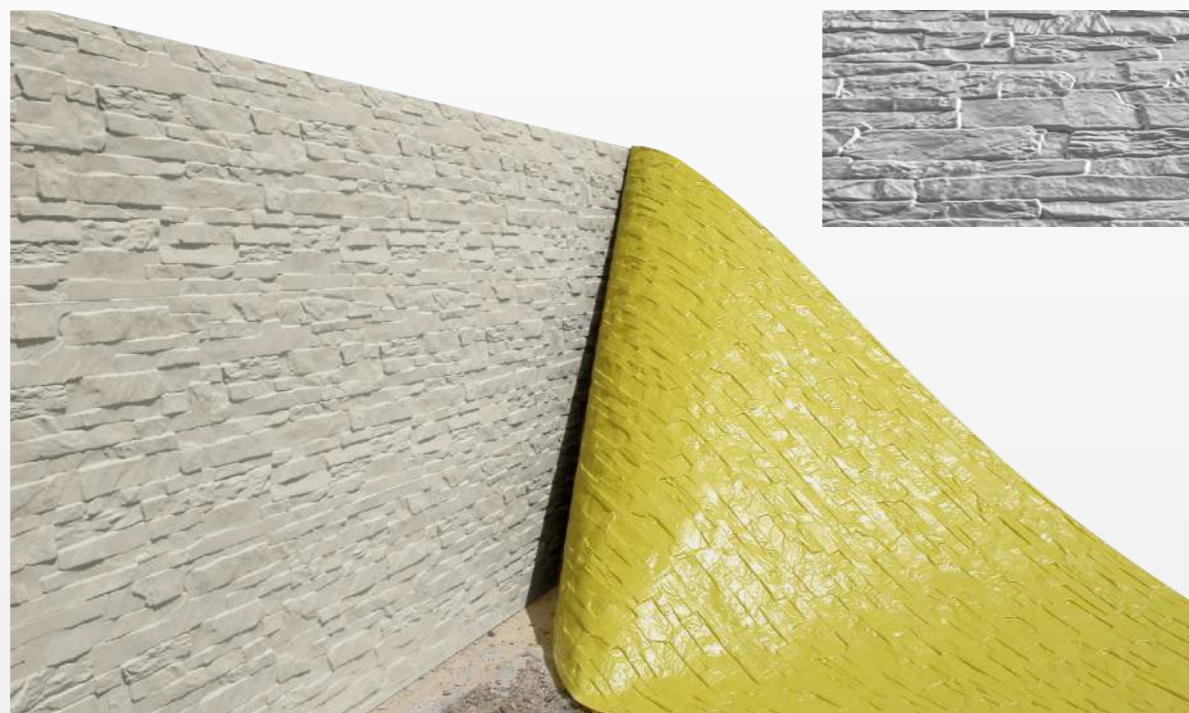
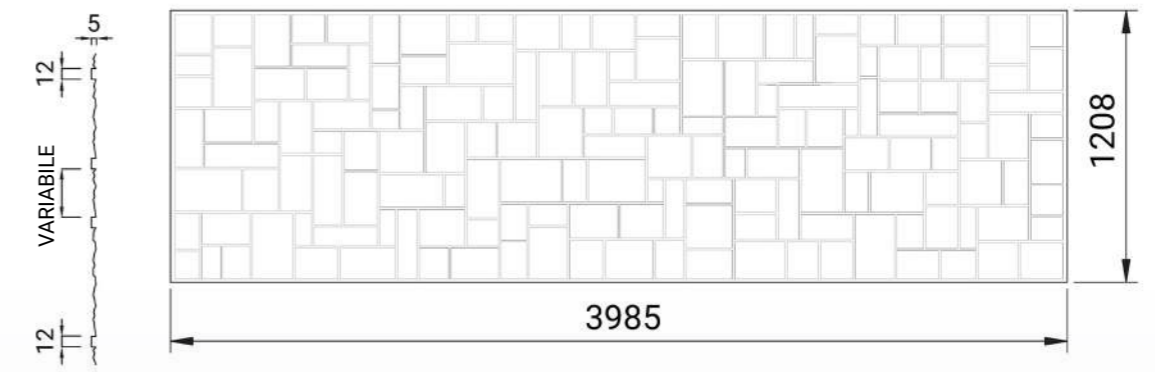

Stone collection

Stone collection

MOD. s54

MOD. s55

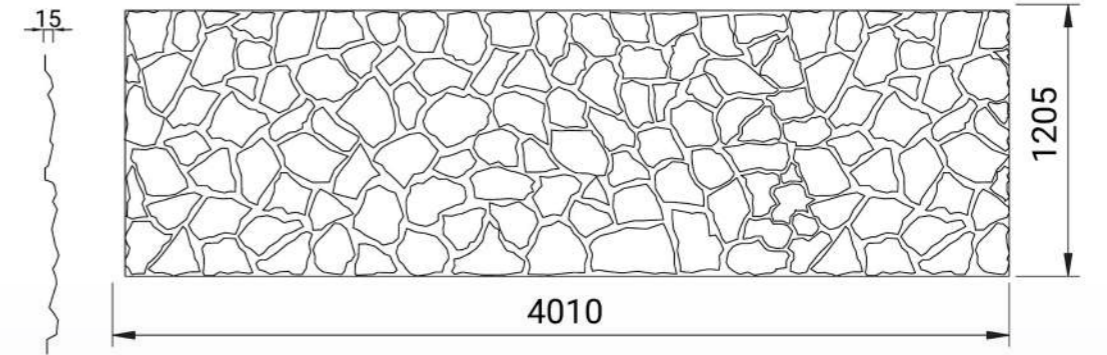
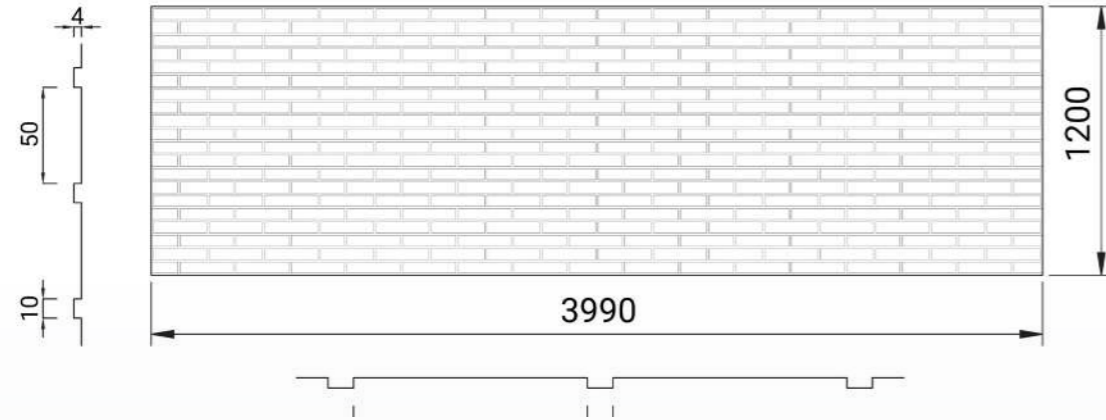

Dettaglio del getto



Dettaglio del getto

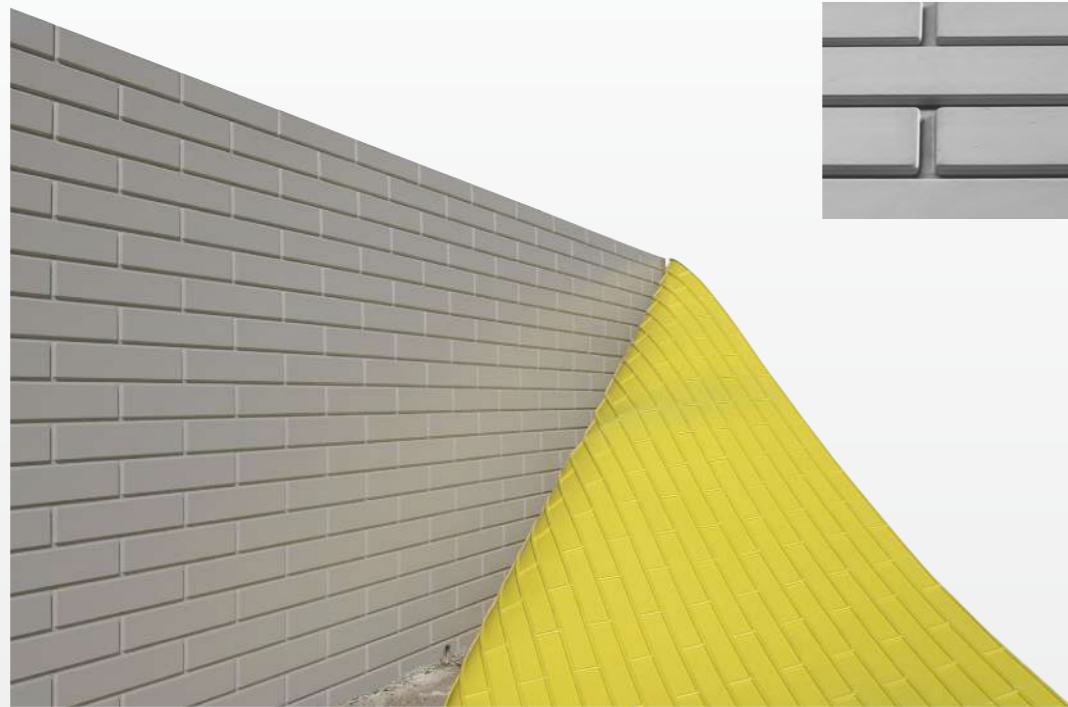
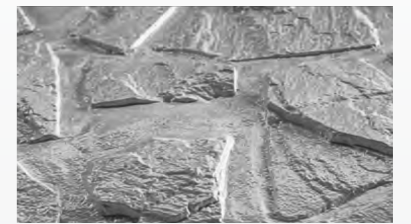

Stone collection

Stone collection

MOD. s56

MOD. s57

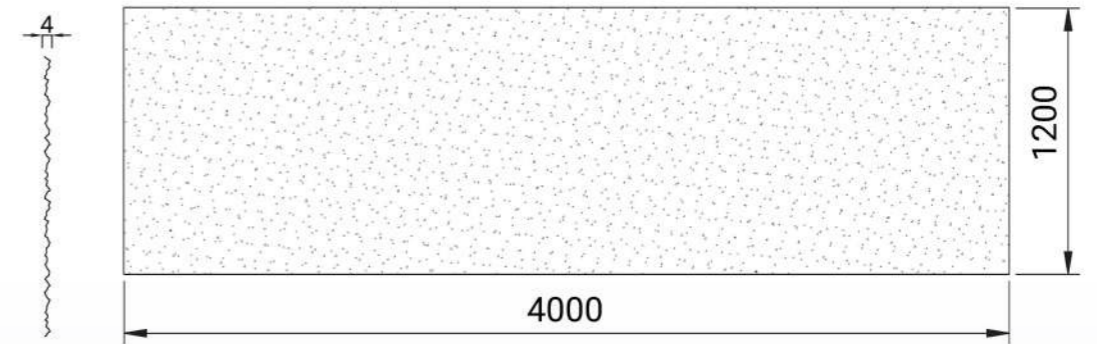
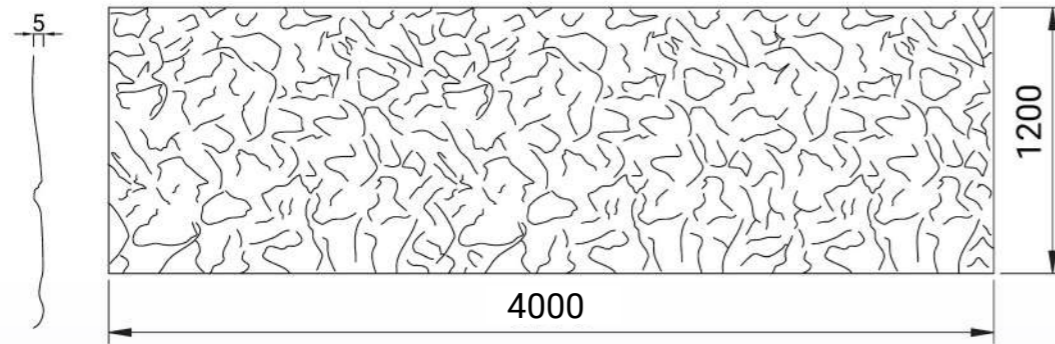

Dettaglio del getto

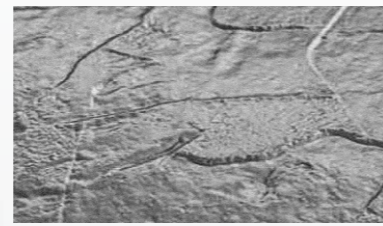

Dettaglio del getto



Stone collection

Stone collection

MOD. s58

MOD. s70

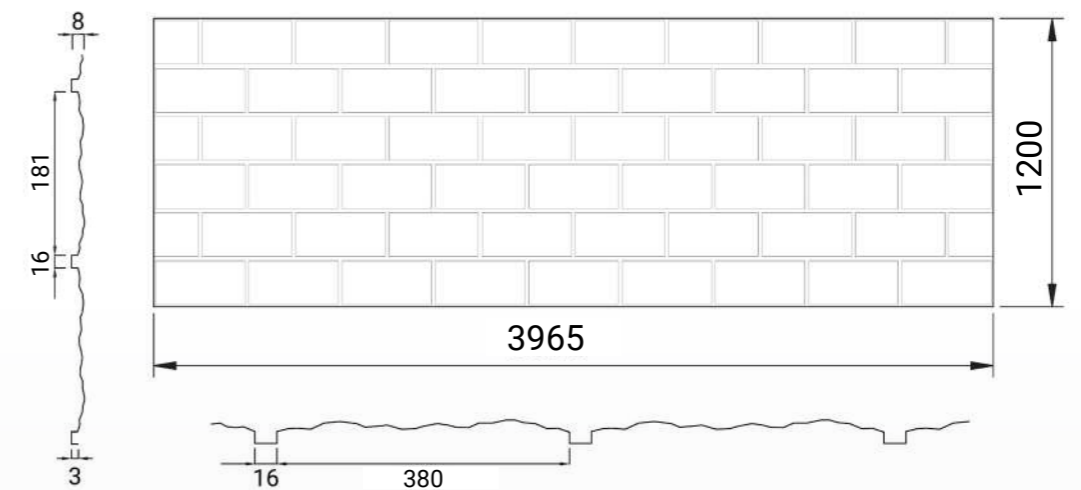
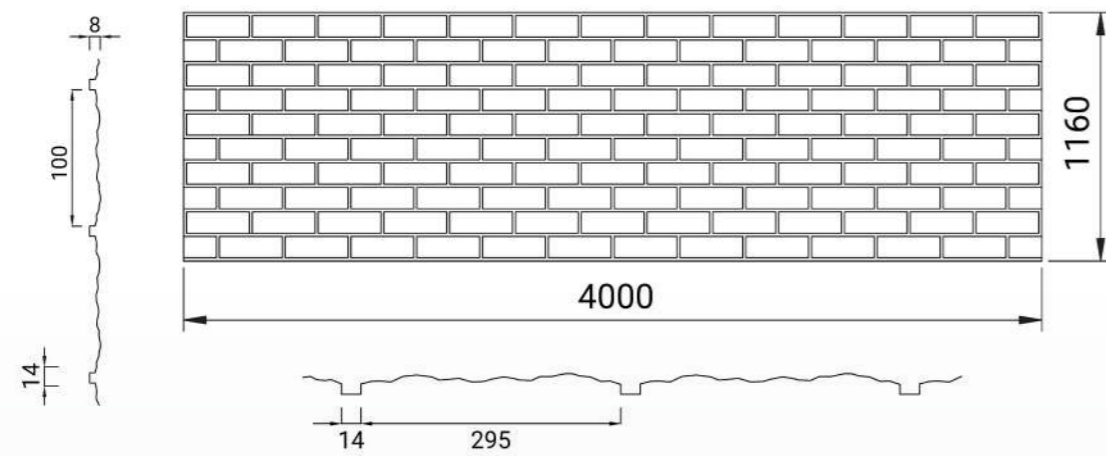

Dettaglio del getto



Dettaglio del getto

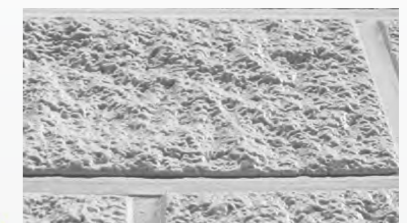

Stone collection

Stone collection

MOD. s76

MOD. s80

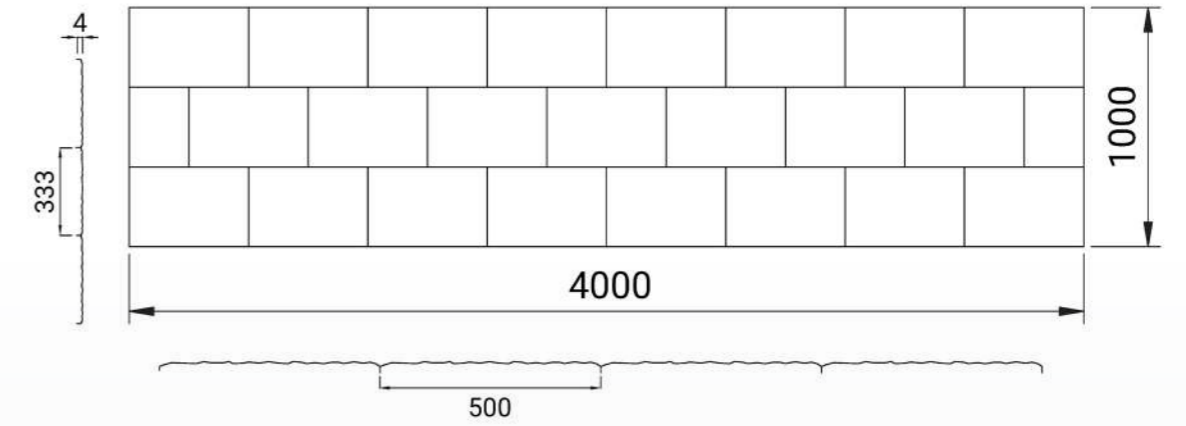
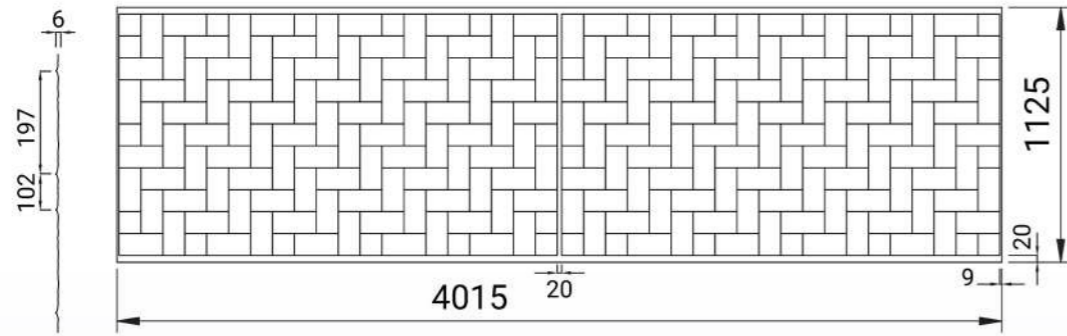

Dettaglio del getto

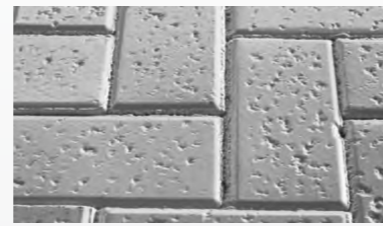

Dettaglio del getto

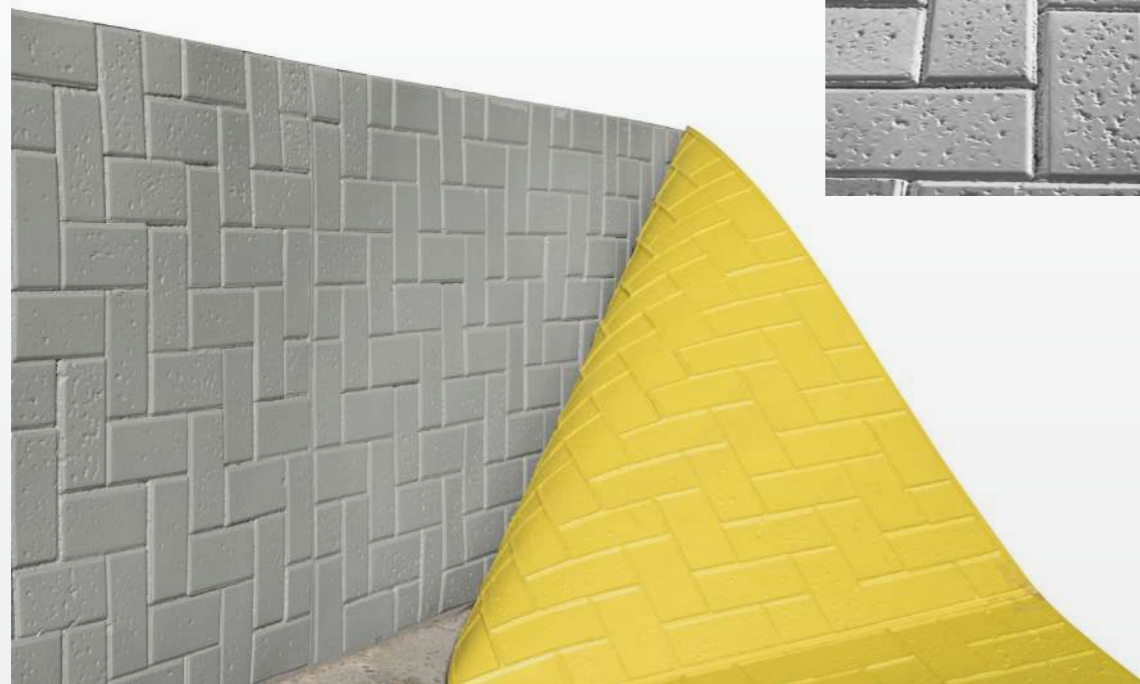

Stone collection

Stone collection

MOD. s81

MOD. s82

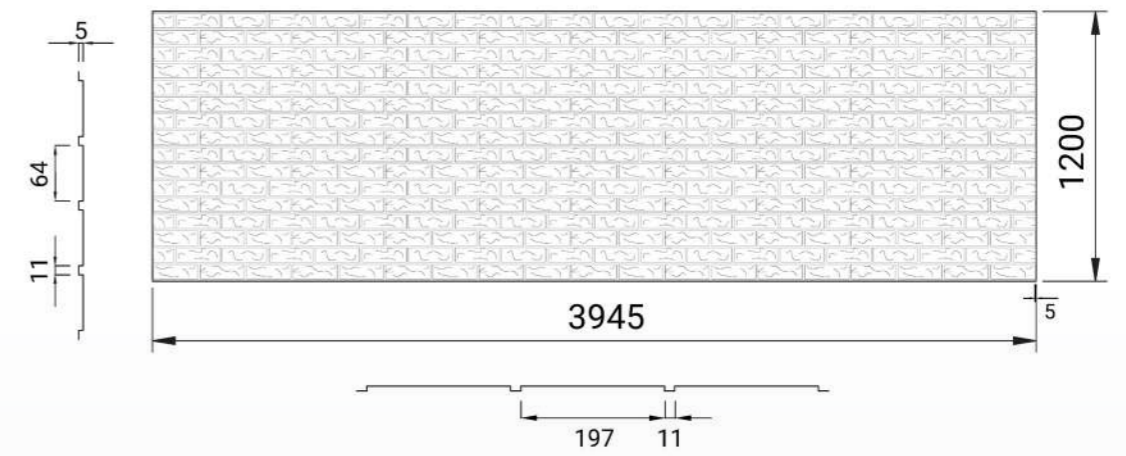
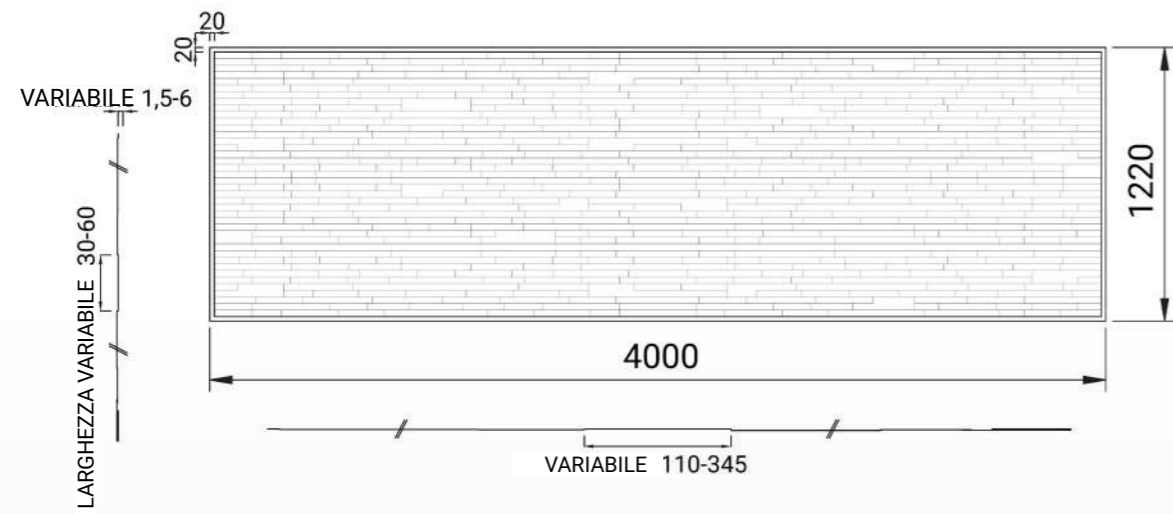

Dettaglio del getto

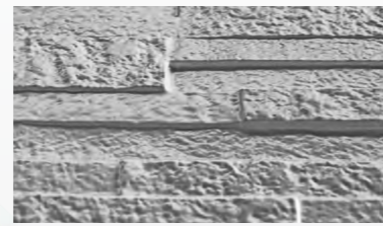

Dettaglio del getto

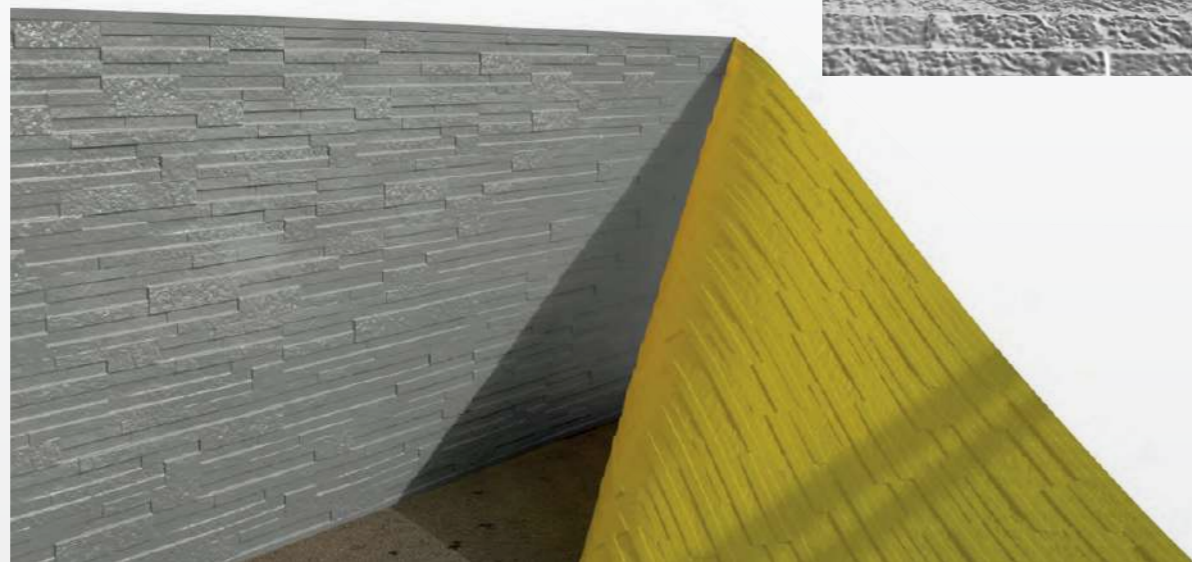
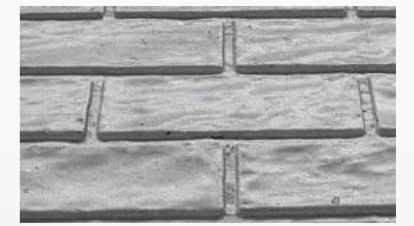

Stone collection

Stone collection

MOD. s83

MOD. s84

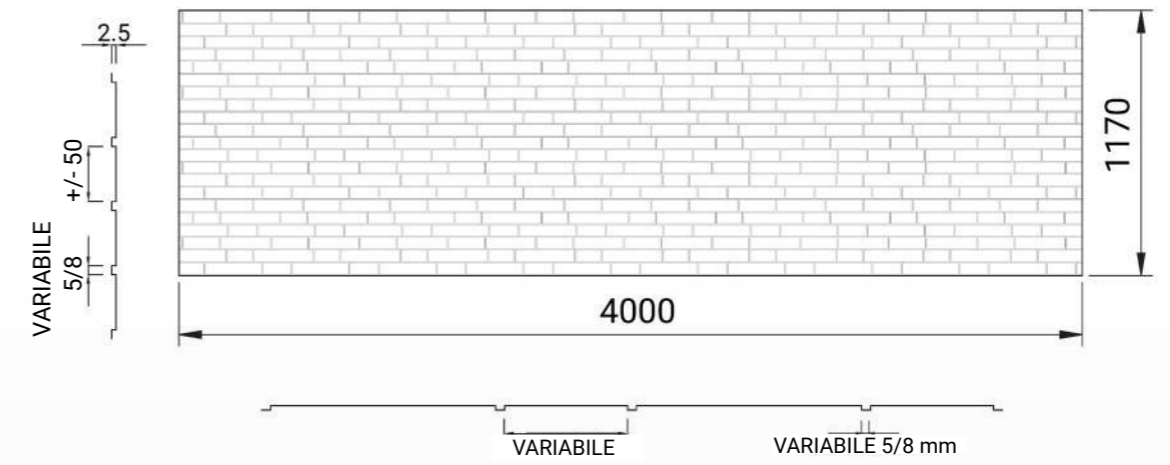
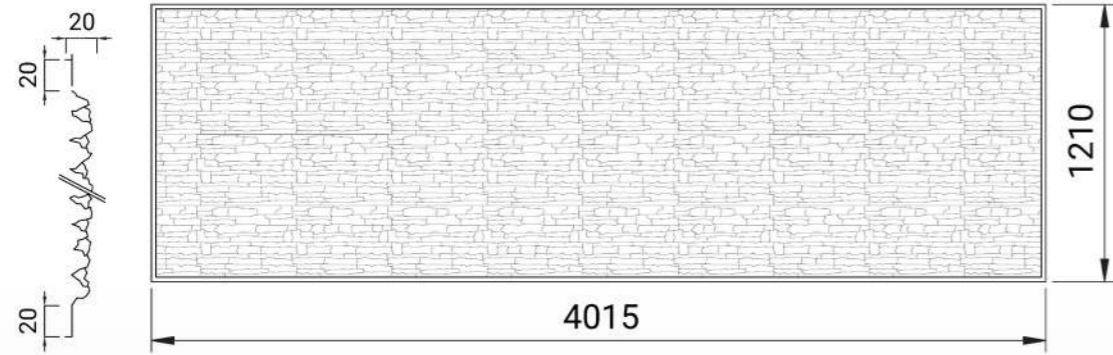

Dettaglio del getto

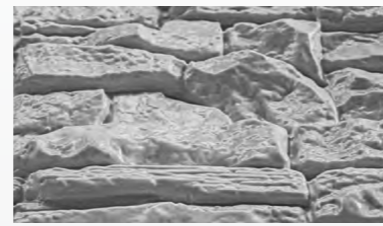

Dettaglio del getto

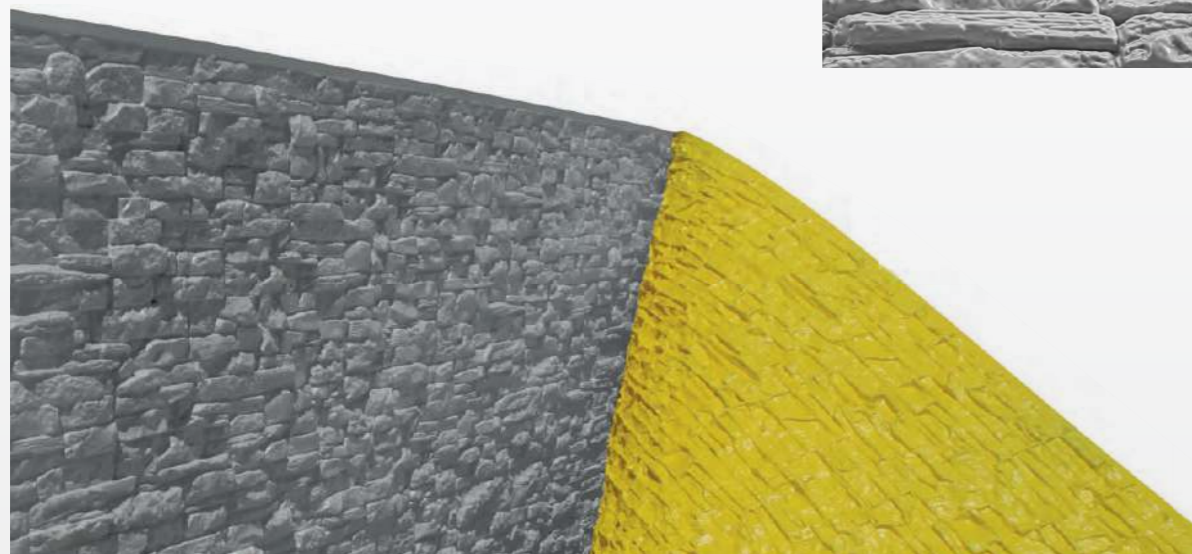
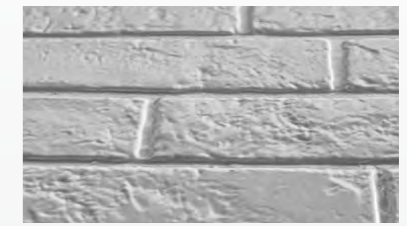

Stone collection

Stone collection

MOD. s87

MOD. L00

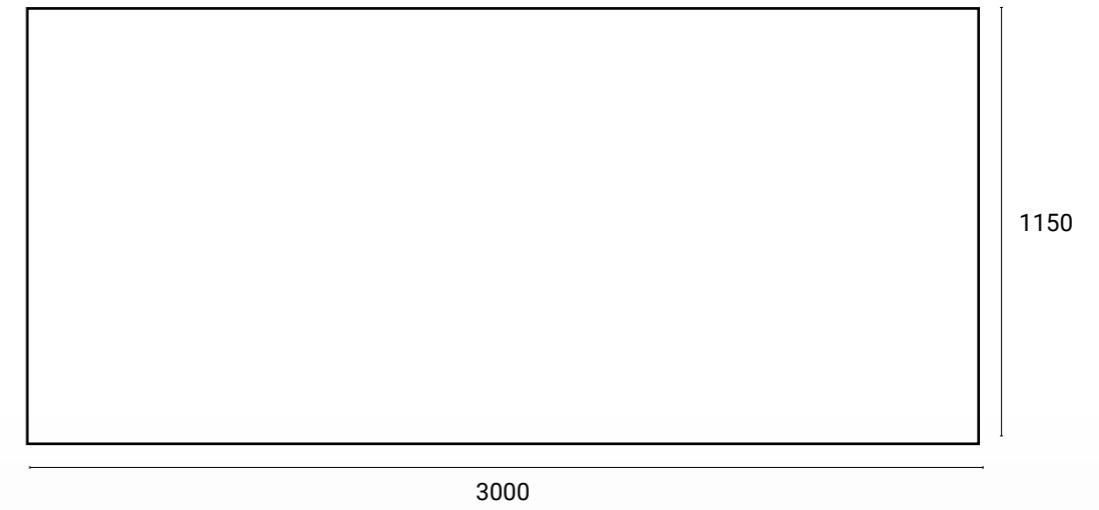
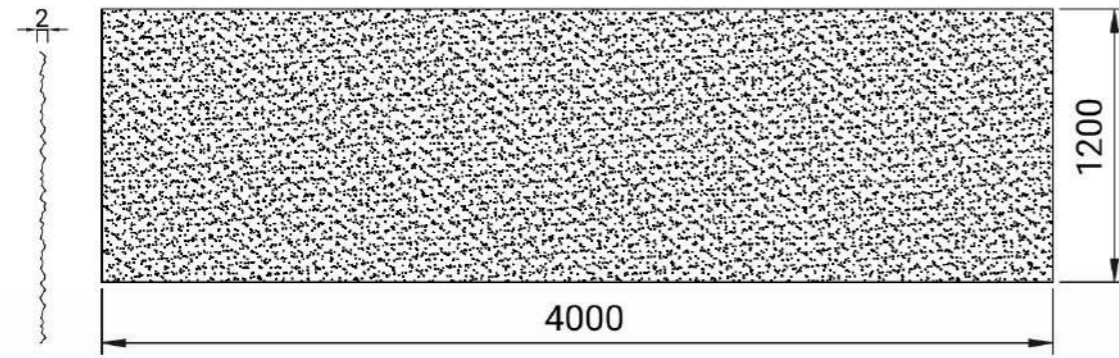

Pannello in MDF da 2,5 mm per getti in calcestruzzo liscio



Stone collection

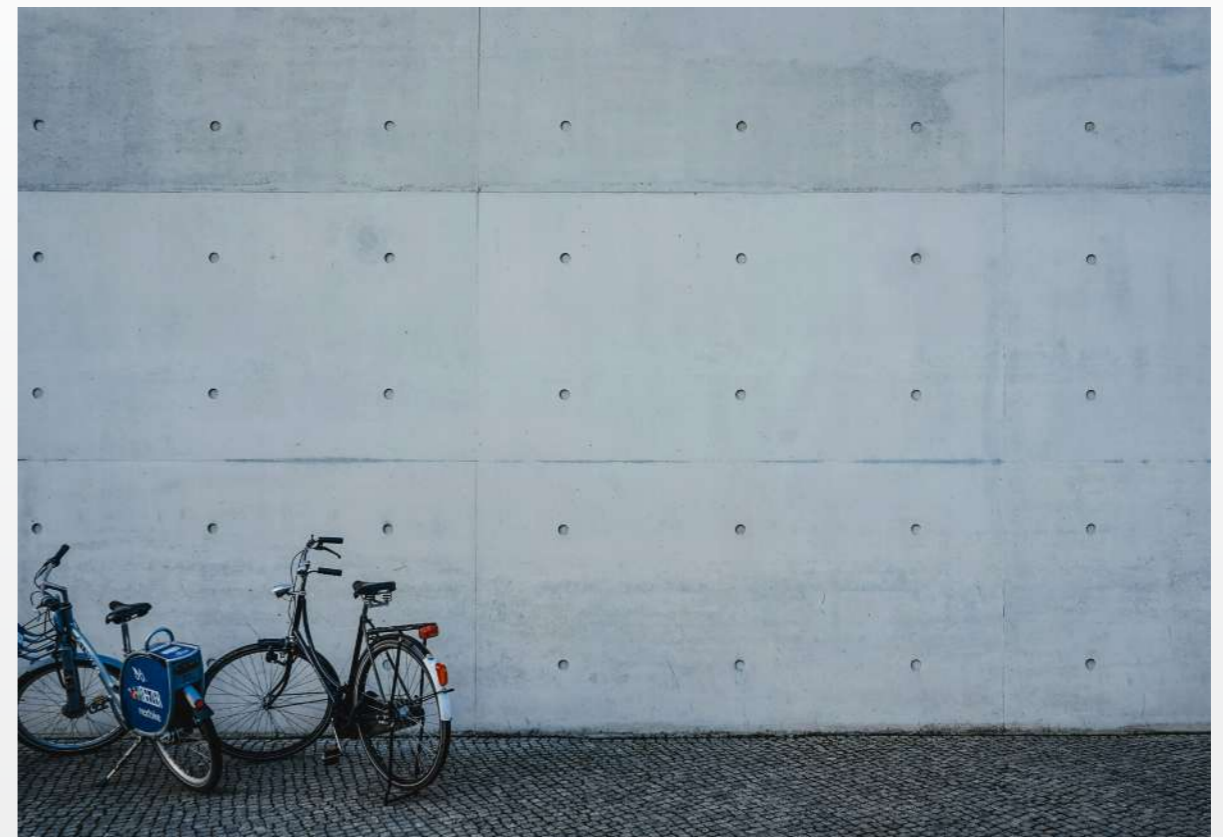

BETON·UNO™

Linea matrici ALTORILIEVO.

Linea di matrici mono-getto dai rilievi molto accentuati, disponibili in 14 tipi di finiture, abbelliscono il calcestruzzo in modo semplice ed economico. Adatte per tutti i tipi di calcestruzzo, anche auto-compattanti, sono garantite per minimo un getto. Posa facile e veloce sui casseri tramite chiodi o con l'apposito adesivo, non necessitano disarmante e quindi i muri possono venire eventualmente tinteggiati immediatamente dopo il disarmo.

Le finiture della serie ALTORILIEVO conferiscono ad una costruzione un gradevole effetto. Possono essere posate all'interno delle casseforme in modo verticale, orizzontale o inclinate, per raggiungere il grado di personalizzazione desiderato. Ideali anche per la realizzazione di muri fonoassorbenti.

Le matrici ALTORILIEVO sono realizzate tramite accoppiatura di una lastra rigida in polistirene HIPS (lato getto) a un supporto in polistirolo ad alta densità.

Le sezioni indicate sono riferite alle matrici.

MOD. 04E

• 4000 x 1200 mm

Dettaglio del getto

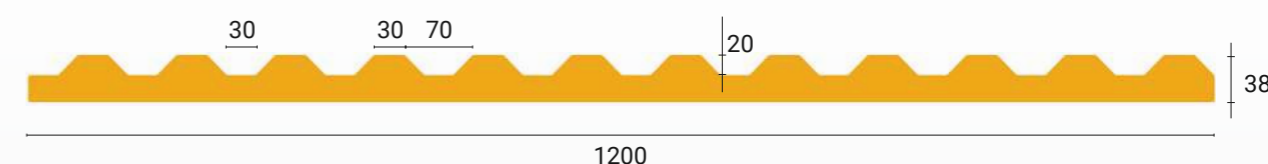
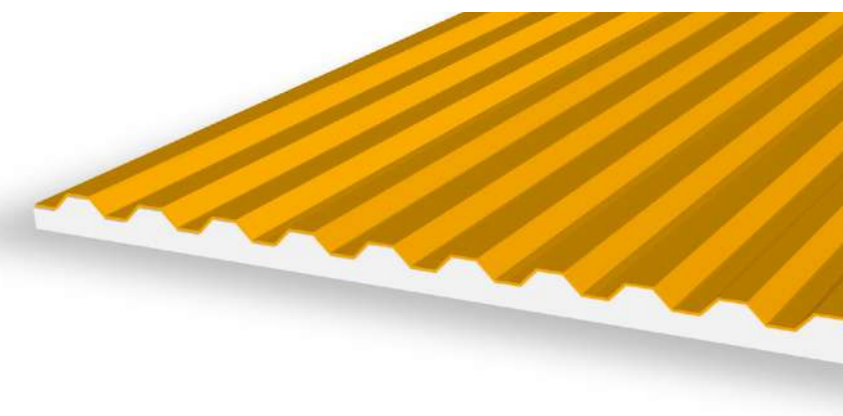
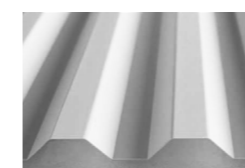

MOD. 05E

• 4000 x 1140 mm

Dettaglio del getto

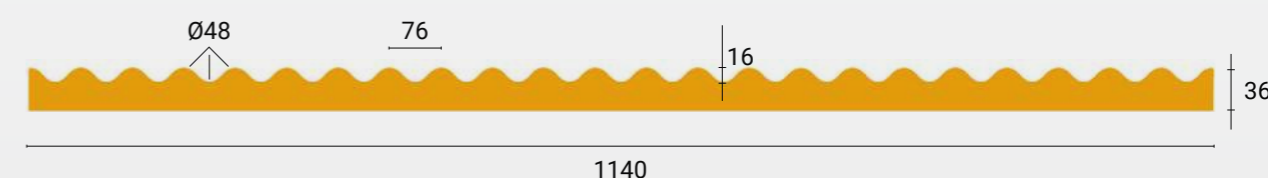
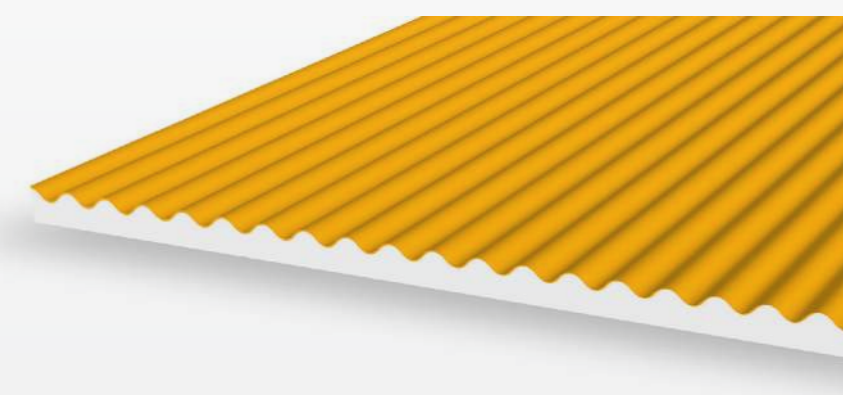
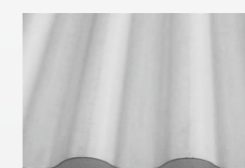

MOD. 06E

• 4000 x 1230 mm

Dettaglio del getto

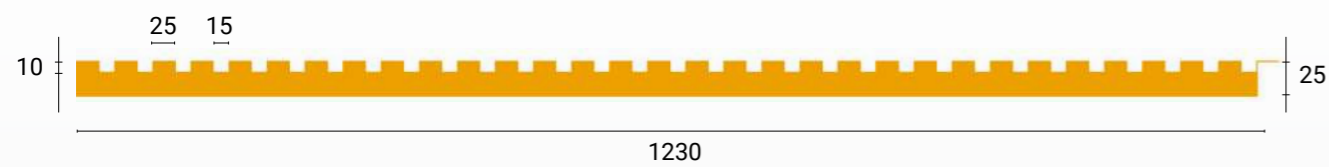
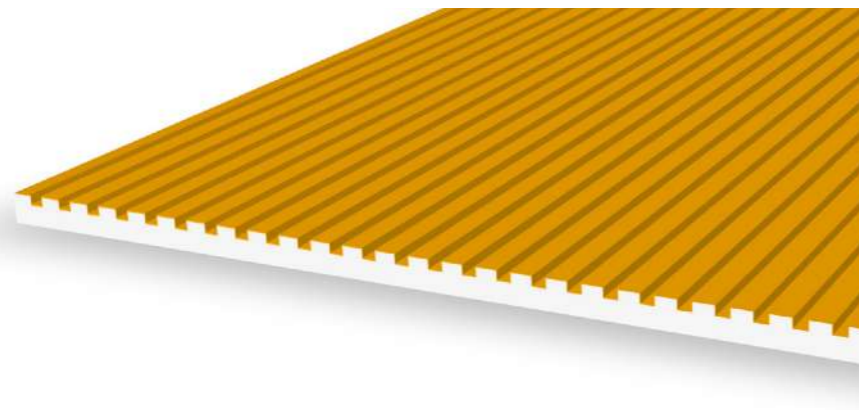
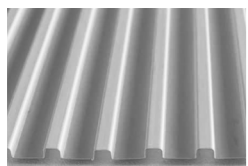

MOD. 09E

• 4000 x 1185 mm

Dettaglio del getto

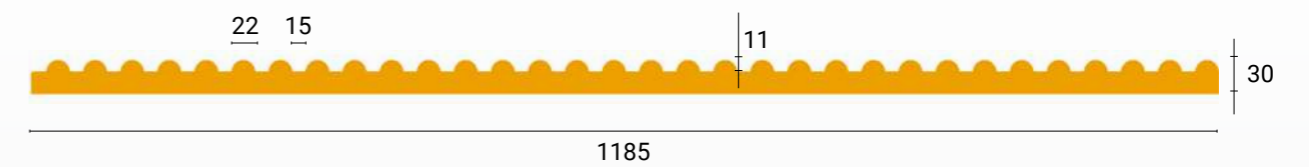
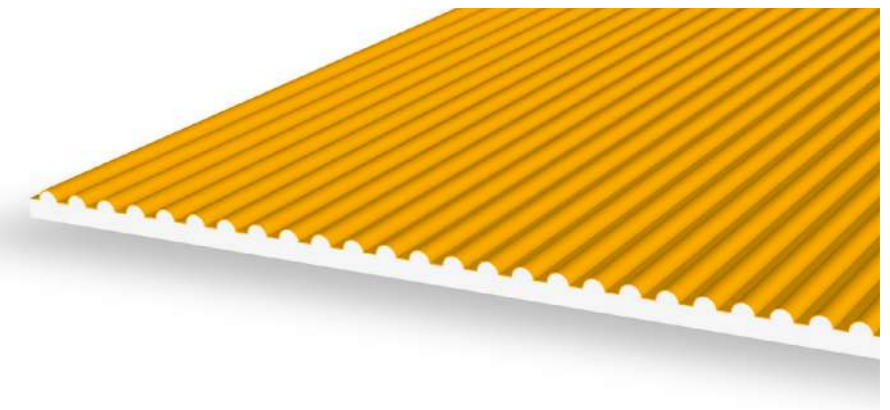
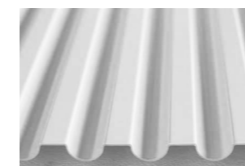

MOD. 08E

• 4000 x 1200 mm

Dettaglio del getto

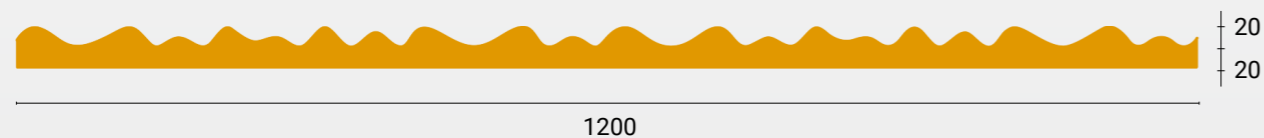
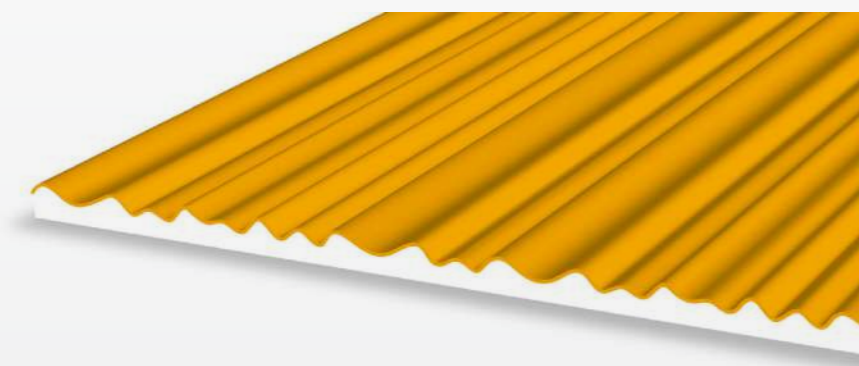

MOD. 10E

• 4000 x 1250 mm

Dettaglio del getto

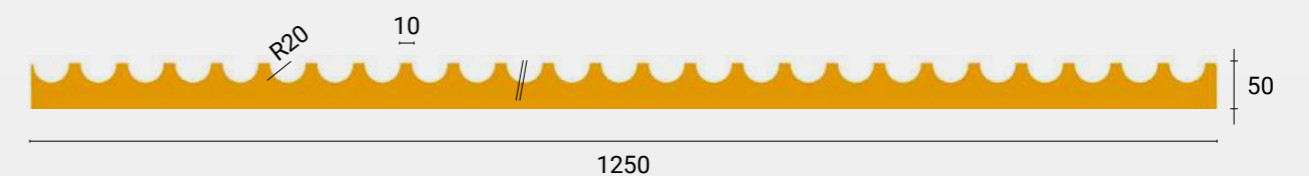
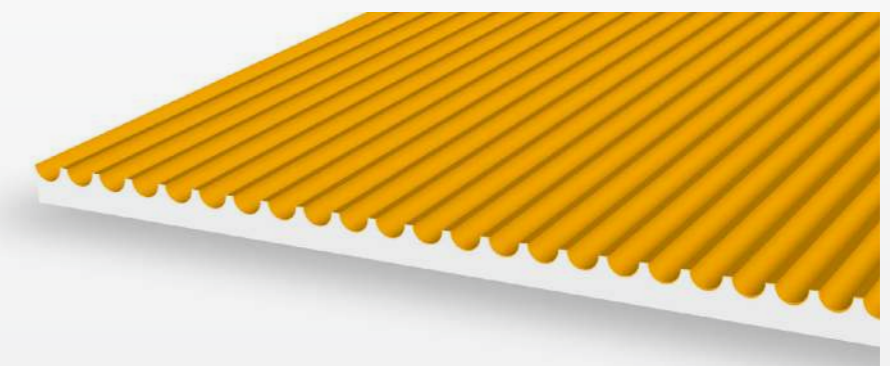
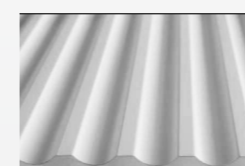

MOD. 11E

• 4000 x 1220 mm

Dettaglio del getto

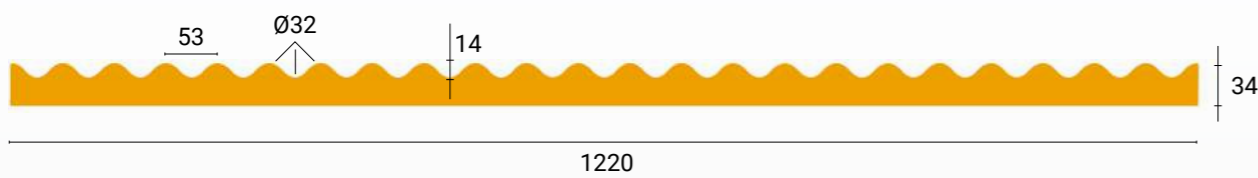
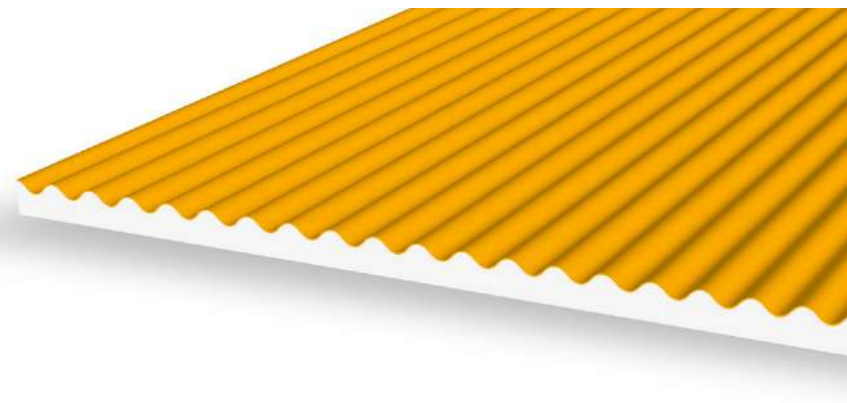
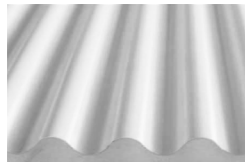

MOD. 14E

• 4000 x 1210 mm

Dettaglio del getto

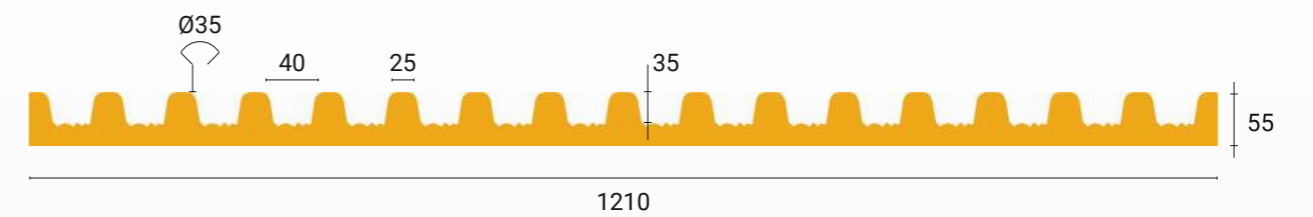
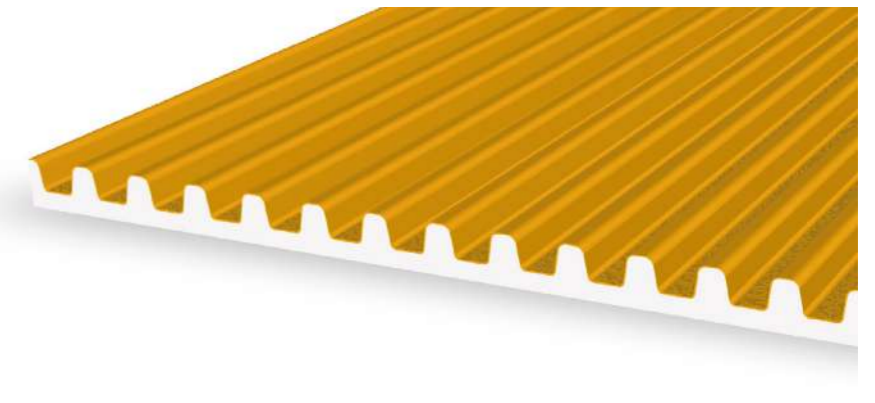
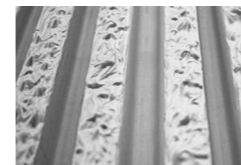

MOD. 13E

• 4000 x 1200 mm

Dettaglio del getto

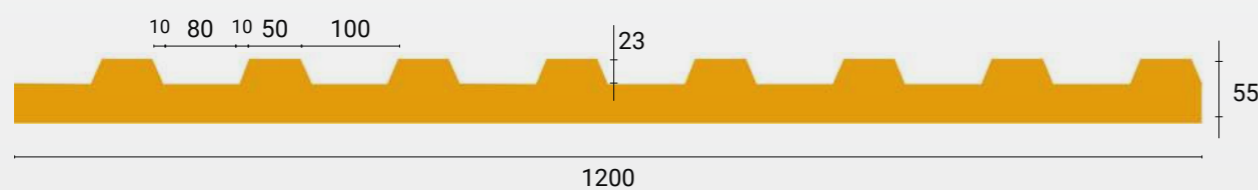
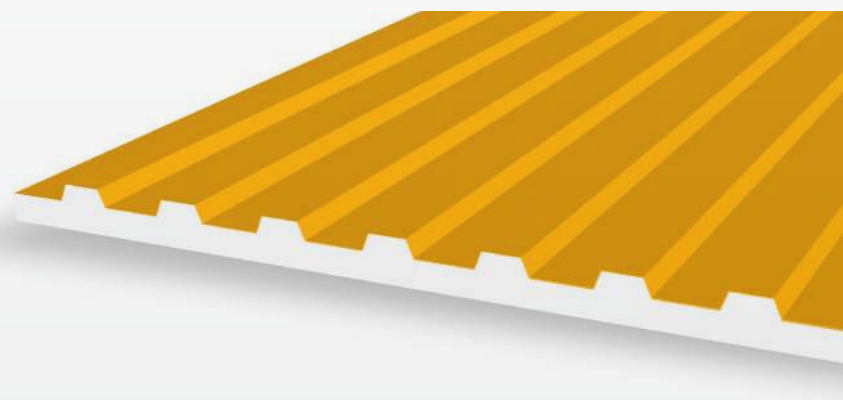
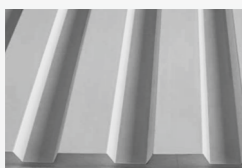

MOD. 15E

• 4000 x 1200 mm

Dettaglio del getto

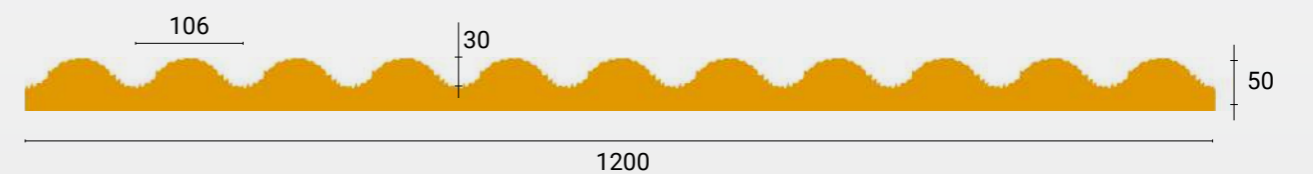
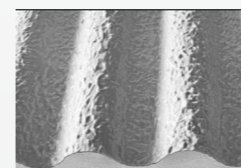

MOD. 16E

• 4000 x 1200 mm

MOD. 30E

• 4000 x 1150 mm

Dettaglio del getto

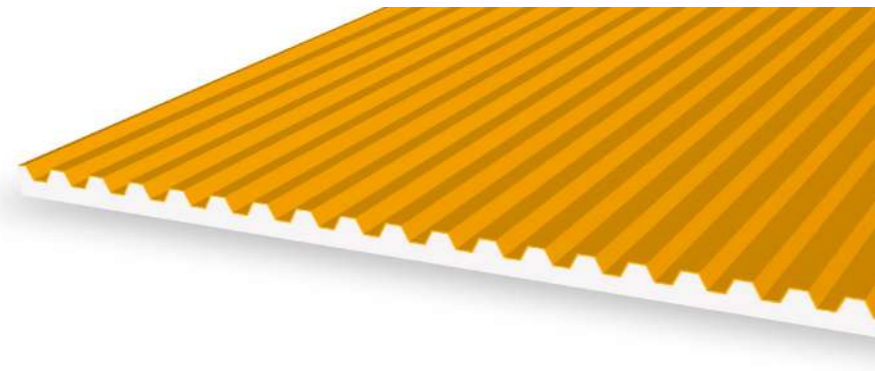
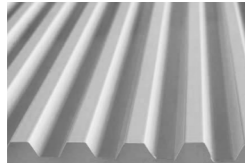

Dettaglio del getto

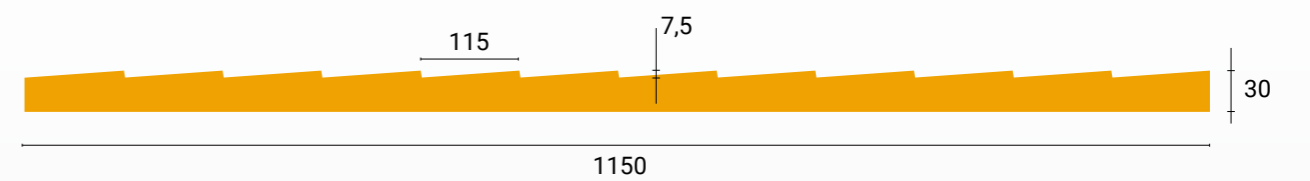
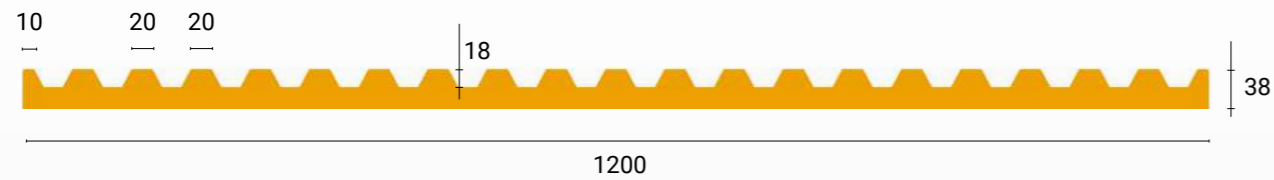
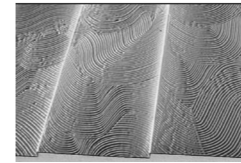

MOD. 24E

• 4000 x 1200 mm

MOD. 31E

• 4000 x 1150 mm

Dettaglio del getto

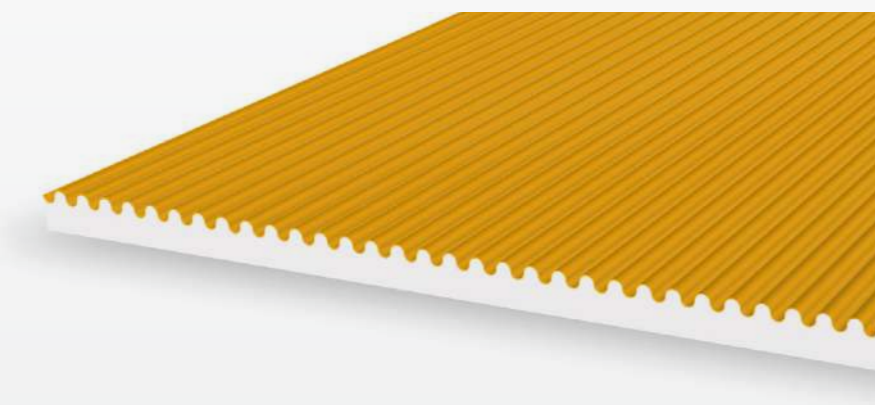
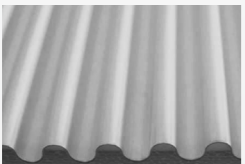

Dettaglio del getto

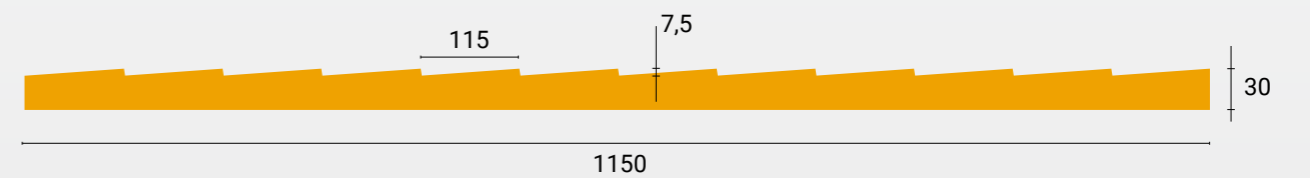
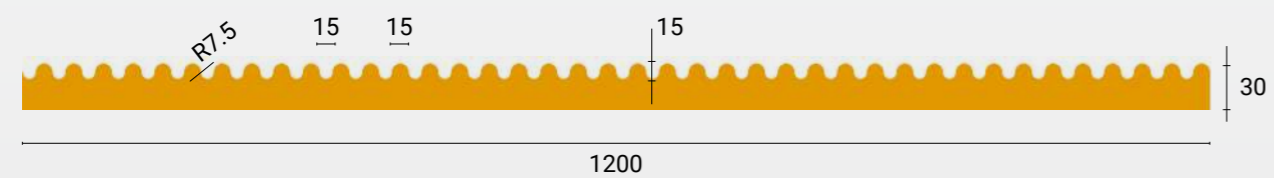
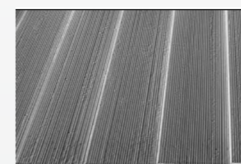

MOD. 62E

• 4000 x 1200 mm

Dettaglio del getto

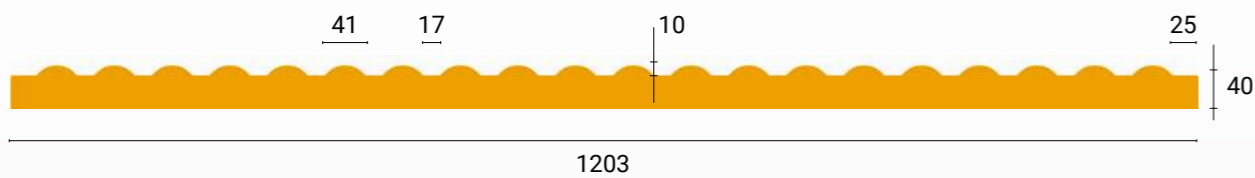
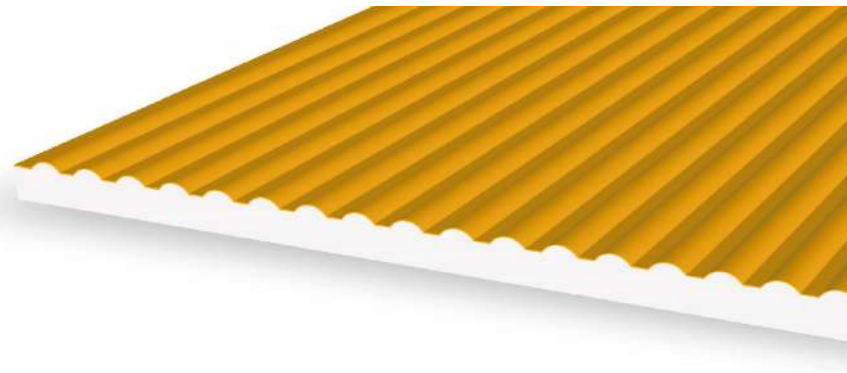
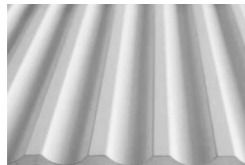

MOD. 69E

• 4000 x 1200 mm

Dettaglio del getto

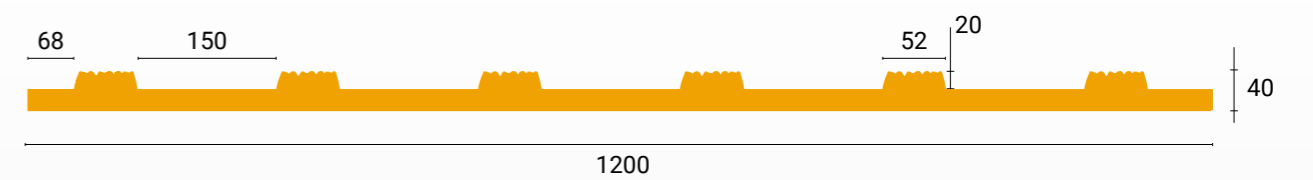
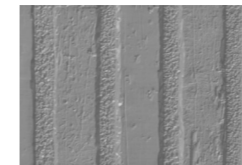

MOD. 67E

• 4000 x 1150 mm

Dettaglio del getto

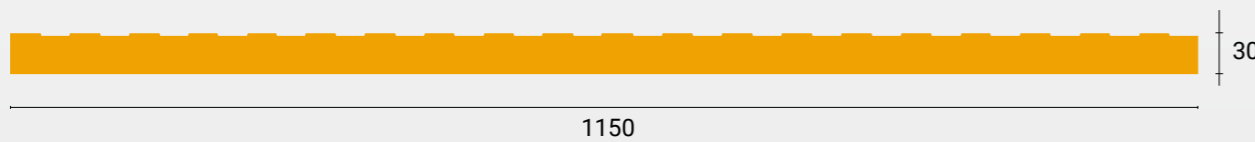

MOD. 70E

• 4000 x 1200 mm

Dettaglio del getto

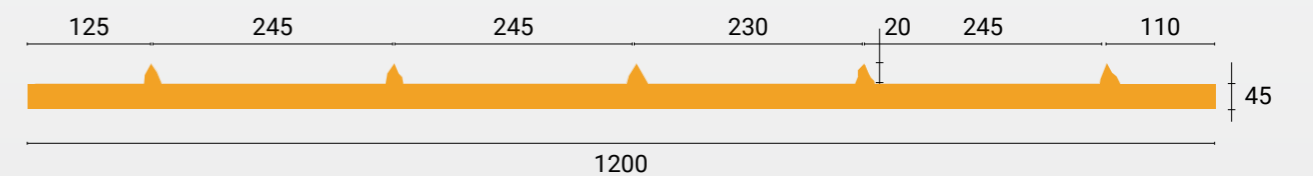
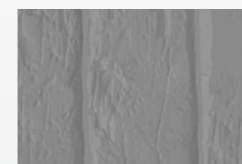

MOD. 71E

• 4000 x 1200 mm

Dettaglio del getto

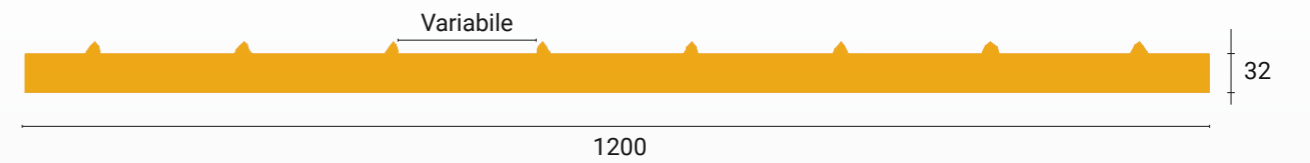
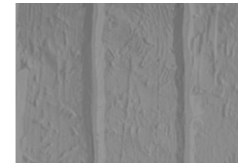

MOD. 80E

• 4000 x 1200 mm

Dettaglio del getto

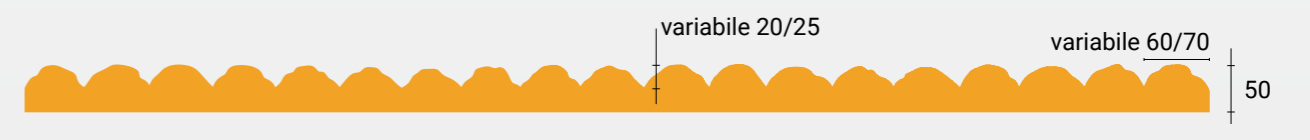
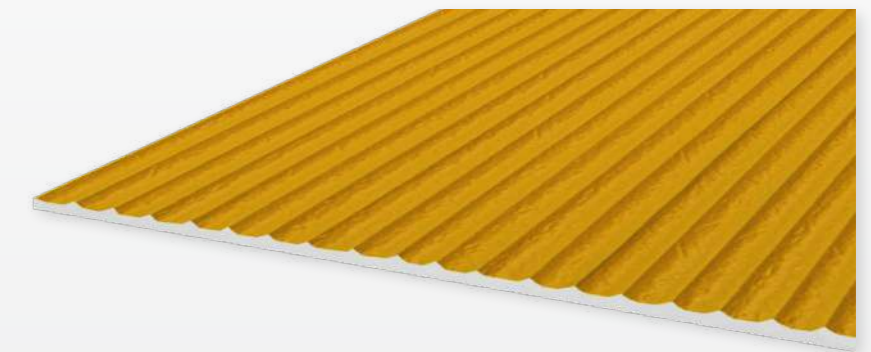
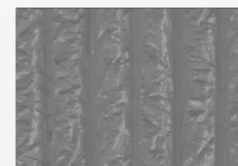

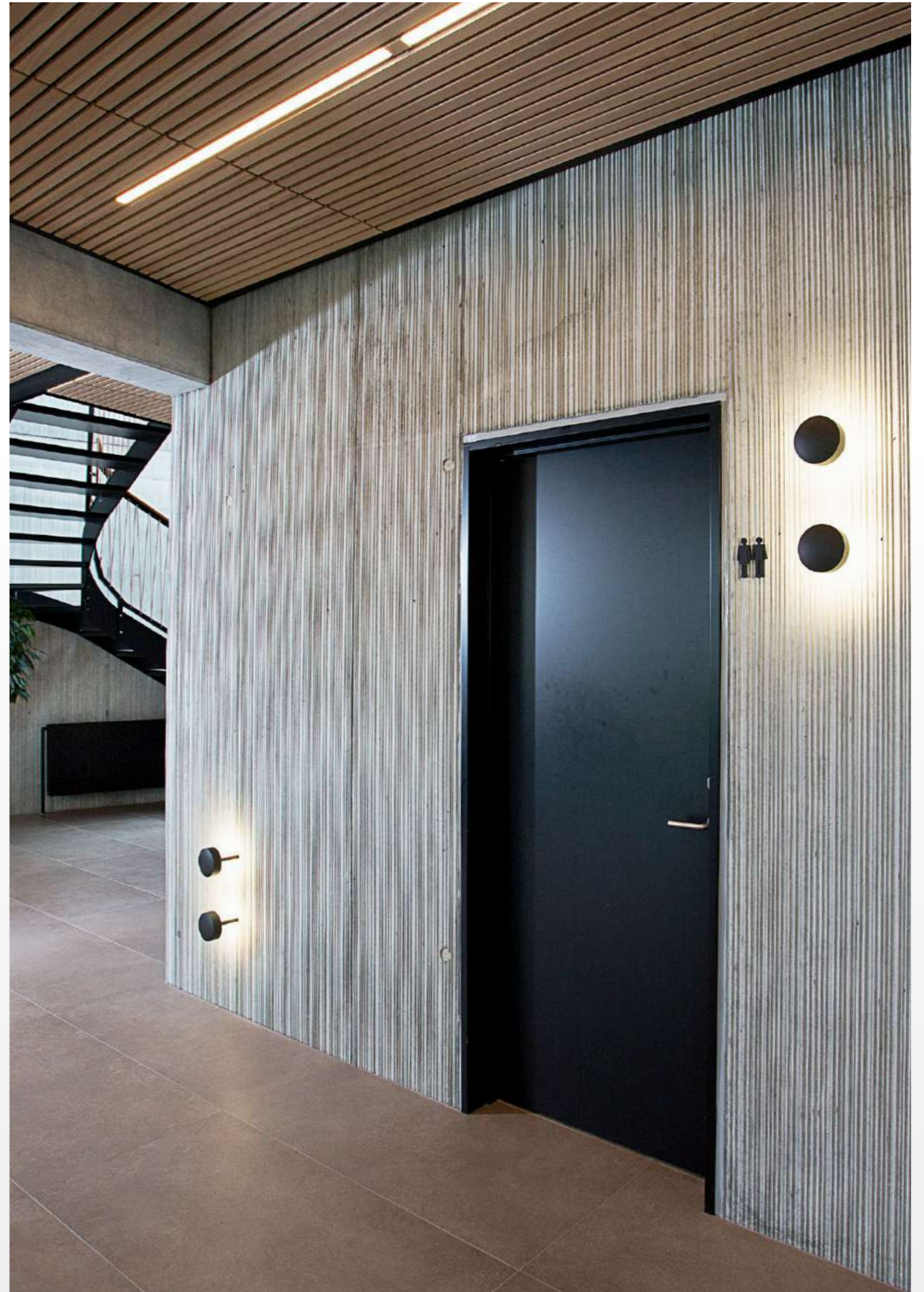

Beton Uno div. Virage Srl

Via Treves 72 - 20090 Trezzano s/Naviglio (MI) / Tel. 02 4840 3101 / info@beton-uno.it
P. Iva/Cod. Fisc./Reg. Impr. Mi IT13360840154 CCIAA Milano R.E.A. - n. 1644962 Cap. soc. Euro 10.000,00 i.v.