



BETONTM -UNO

Matrici per calcestruzzo a faccia vista

BETON UNO™

Indice

Linea matrici *STANDARD*

4

MOD. w01 <i>_Wood Collection</i> pag 5	MOD. F37 <i>_Form Collection</i> pag 30
MOD. w02 <i>_Wood Collection</i> pag 6	MOD. F61 <i>_Form Collection</i> pag 31
MOD. w03 <i>_Wood Collection</i> pag 7	MOD. F66 <i>_Form Collection</i> pag 32
MOD. w04 <i>_Wood Collection</i> pag 8	MOD. F75 <i>_Form Collection</i> pag 33
MOD. w05 <i>_Wood Collection</i> pag 9	MOD. F77 <i>_Form Collection</i> pag 34
MOD. w06 <i>_Wood Collection</i> pag 10	MOD. F85 <i>_Form Collection</i> pag 35
MOD. w07 <i>_Wood Collection</i> pag 11	MOD. F86 <i>_Form Collection</i> pag 36
MOD. w08 <i>_Wood Collection</i> pag 12	MOD. F88 <i>_Form Collection</i> pag 37
MOD. w09 <i>_Wood Collection</i> pag 13	MOD. s51 <i>_Stone Collection</i> pag 38
MOD. w11 <i>_Wood Collection</i> pag 14	MOD. s53 <i>_Stone Collection</i> pag 39
MOD. w12 <i>_Wood Collection</i> pag 15	MOD. s54 <i>_Stone Collection</i> pag 40
MOD. w15 <i>_Wood Collection</i> pag 16	MOD. s55 <i>_Stone Collection</i> pag 41
MOD. w16 <i>_Wood Collection</i> pag 17	MOD. s56 <i>_Stone Collection</i> pag 42
MOD. w74 <i>_Wood Collection</i> pag 18	MOD. s57 <i>_Stone Collection</i> pag 43
MOD. F21 <i>_Form Collection</i> pag 20	MOD. s58 <i>_Stone Collection</i> pag 44
MOD. F22 <i>_Form Collection</i> pag 21	MOD. s70 <i>_Stone Collection</i> pag 45
MOD. F23 <i>_Form Collection</i> pag 22	MOD. s76 <i>_Stone Collection</i> pag 46
MOD. F28 <i>_Form Collection</i> pag 23	MOD. s80 <i>_Stone Collection</i> pag 47
MOD. F29 <i>_Form Collection</i> pag 24	MOD. s81 <i>_Stone Collection</i> pag 48
MOD. F30 <i>_Form Collection</i> pag 25	MOD. s82 <i>_Stone Collection</i> pag 49
MOD. F31 <i>_Form Collection</i> pag 26	MOD. s83 <i>_Stone Collection</i> pag 50
MOD. F34 <i>_Form Collection</i> pag 27	MOD. s84 <i>_Stone Collection</i> pag 51
MOD. F35 <i>_Form Collection</i> pag 28	MOD. s87 <i>_Stone Collection</i> pag 52
MOD. F36 <i>_Form Collection</i> pag 29	MOD. L00 pag 53

Linea matrici *ALTORILIEVO*

54

MOD. 04E pag 55	MOD. 16E pag 60
MOD. 05E pag 55	MOD. 24E pag 60
MOD. 06E pag 56	MOD. 30E pag 61
MOD. 08E pag 56	MOD. 31E pag 61
MOD. 09E pag 57	MOD. 62E pag 62
MOD. 10E pag 57	MOD. 67E pag 62
MOD. 11E pag 58	MOD. 69E pag 63
MOD. 13E pag 58	MOD. 70E pag 63
MOD. 14E pag 59	MOD. 71E pag 65
MOD. 15E pag 59	MOD. 80E pag 65

E' il momento della massima resa,
della praticità e della differenza.
Tutto con estrema facilità!

Linea matrici STANDARD.

Linea di matrici mono-getto dai rilievi poco accentuati, disponibili in una quarantina di disegni, abbelliscono il calcestruzzo in modo semplice ed economico. Adatte per tutti i tipi di calcestruzzo, anche auto-compattanti, sono garantite per minimo un getto. Posa facile e veloce sui casseri tramite chiodi o con l'apposito adesivo, non necessitano disarmante e quindi i muri possono venire eventualmente tinteggiati immediatamente dopo il disarmo.

Le finiture della serie STANDARD conferiscono al calcestruzzo gettato superfici discrete ed eleganti o, a vostra scelta, dei disegni più pronunciati.

Le misure sono espresse in mm.

MOD. w01

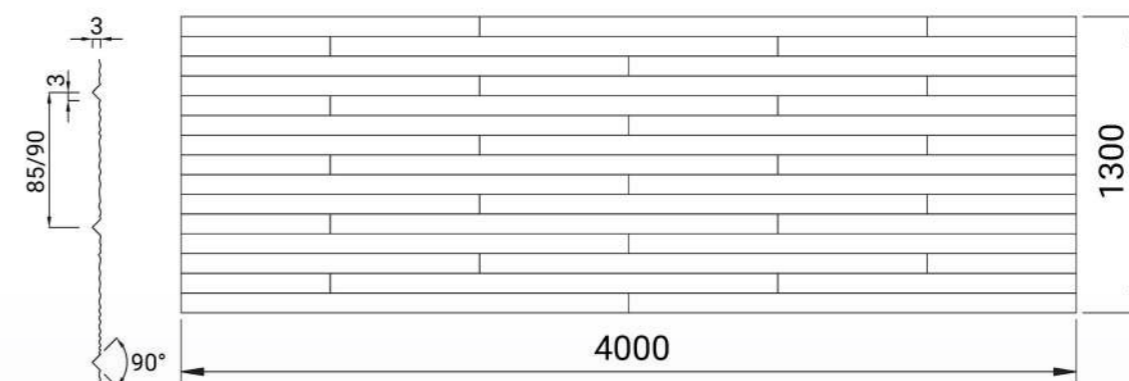

Dettaglio del getto



Wood collection

MOD. W02

MOD. W03

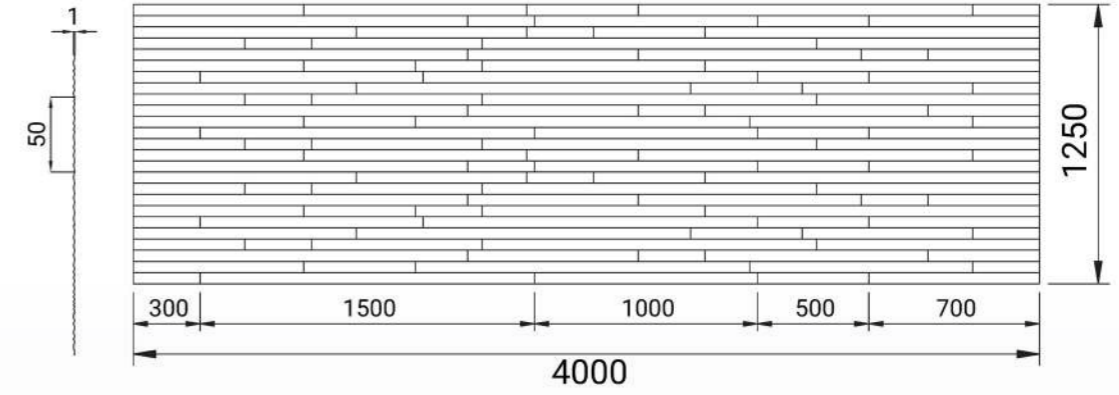
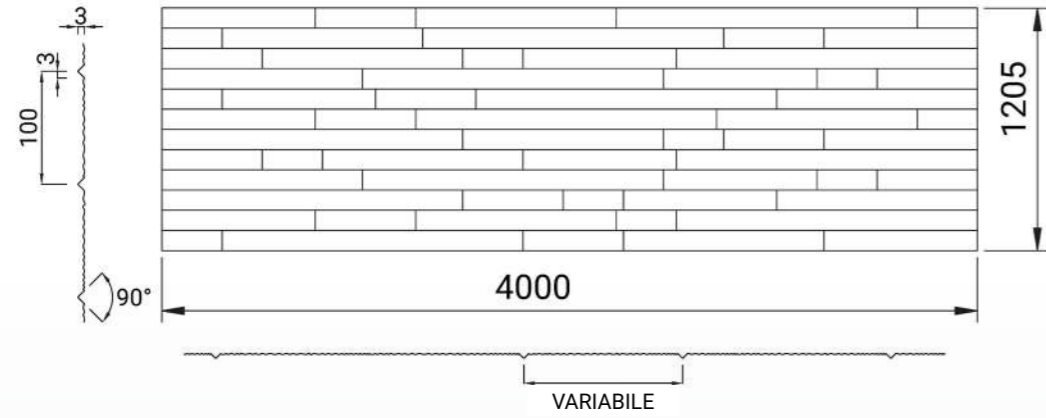

Dettaglio del getto

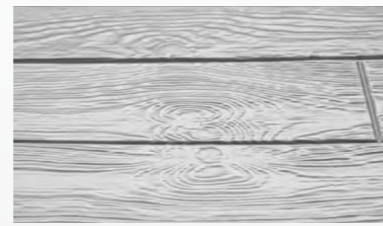

Dettaglio del getto

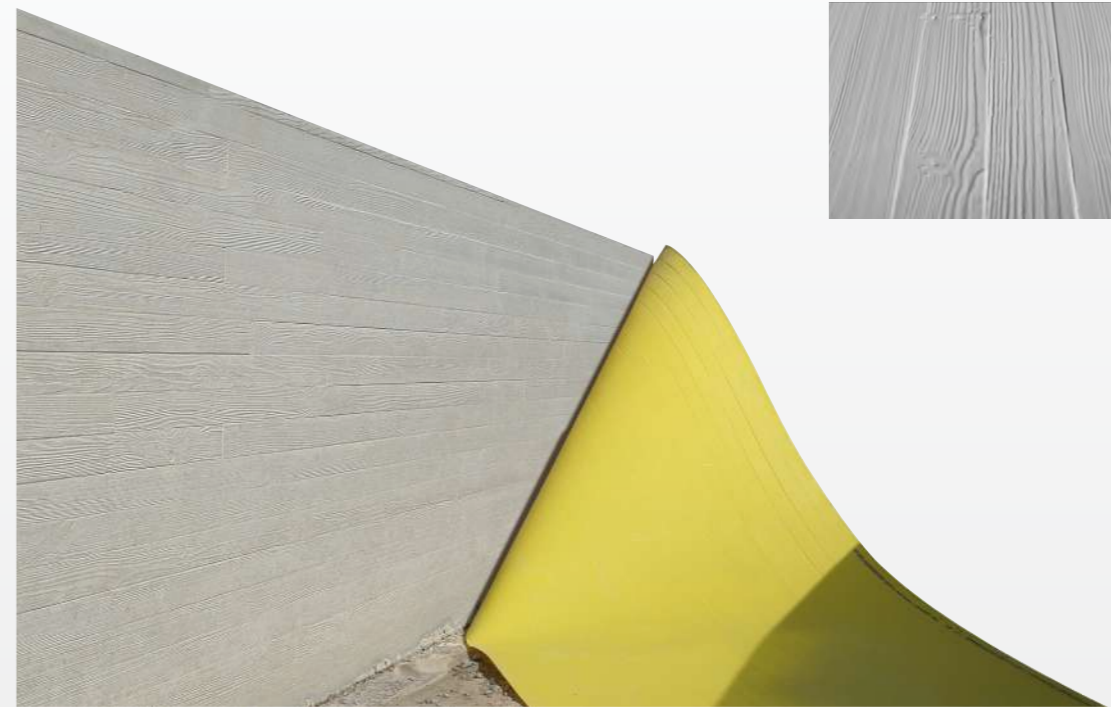
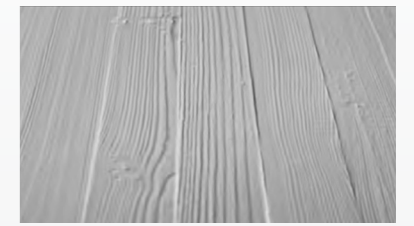

Wood collection

Wood collection

MOD. w04

MOD. w05

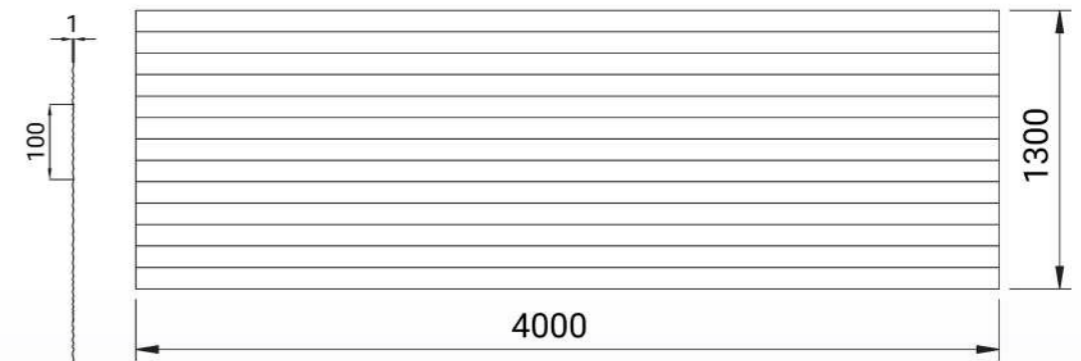
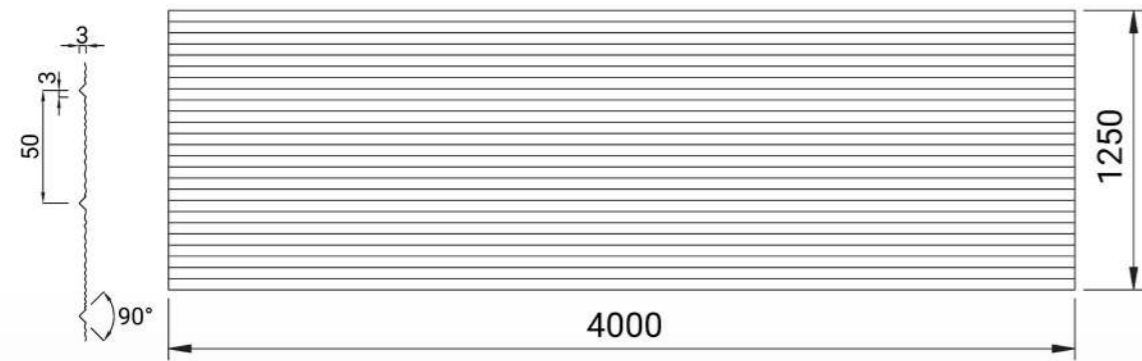

Dettaglio del getto

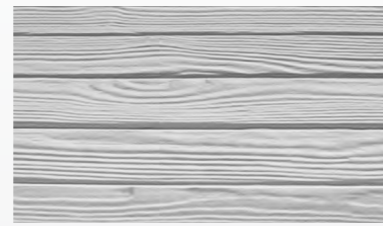

Dettaglio del getto

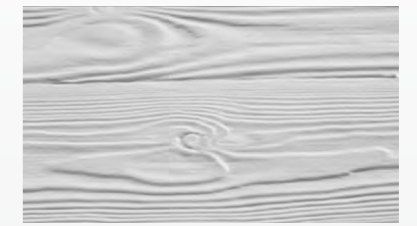

Wood collection

Wood collection

MOD. w06

MOD. w07

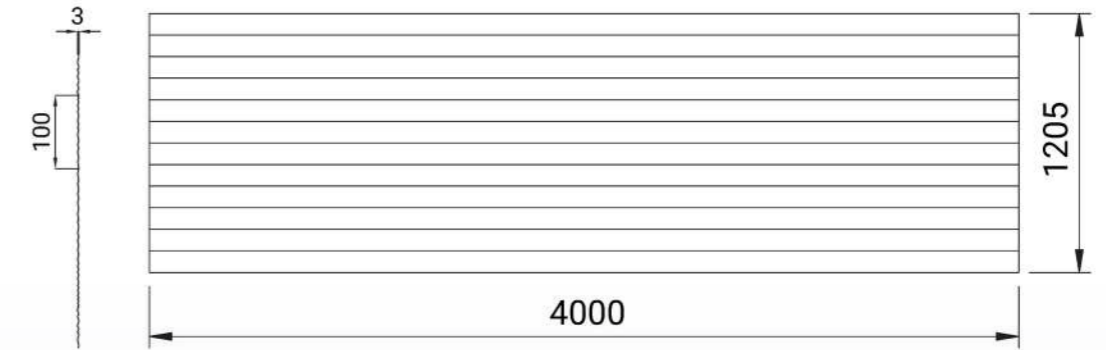
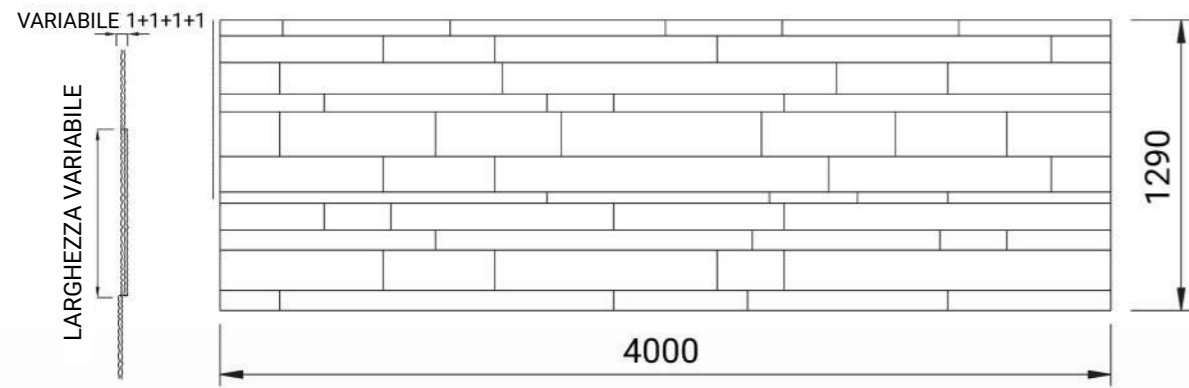

Dettaglio del getto

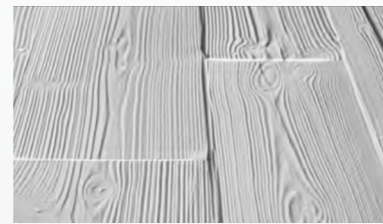

Dettaglio del getto

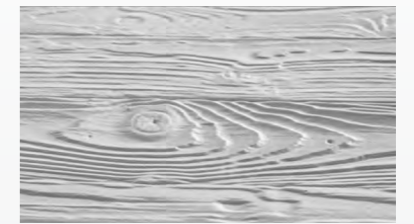

Wood collection

Wood collection

MOD. W08

MOD. W09

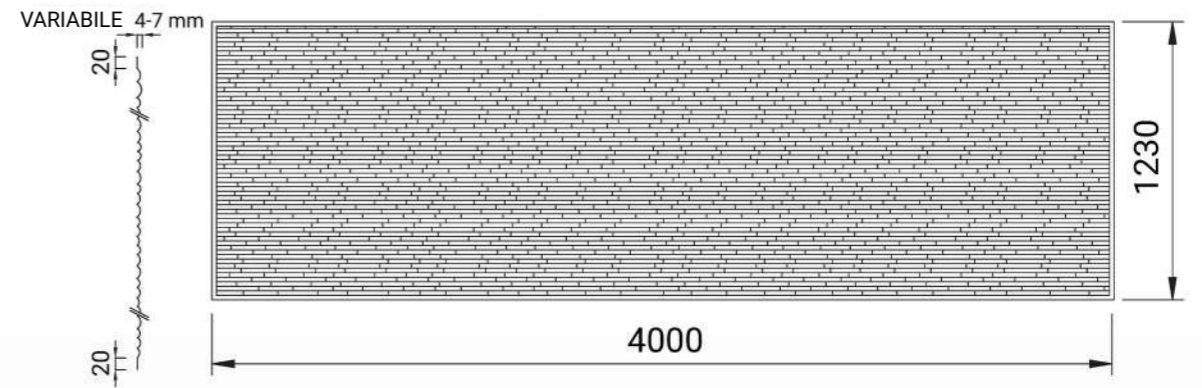
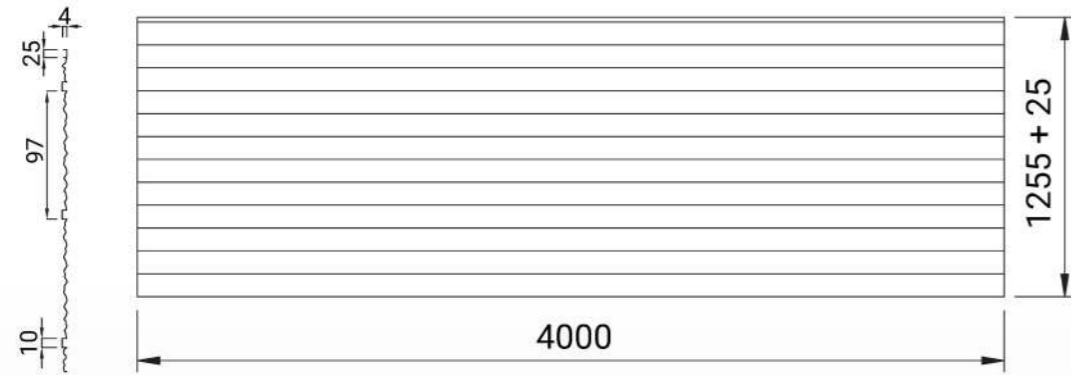

Dettaglio del getto

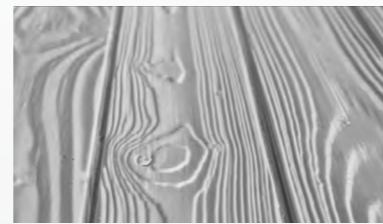

Dettaglio del getto

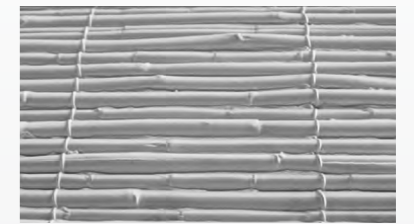

Wood collection

Wood collection

MOD. W11

MOD. W12

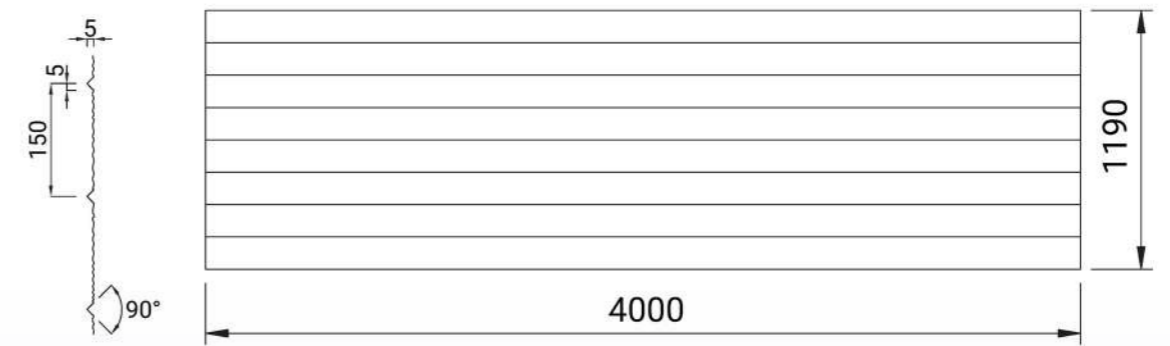
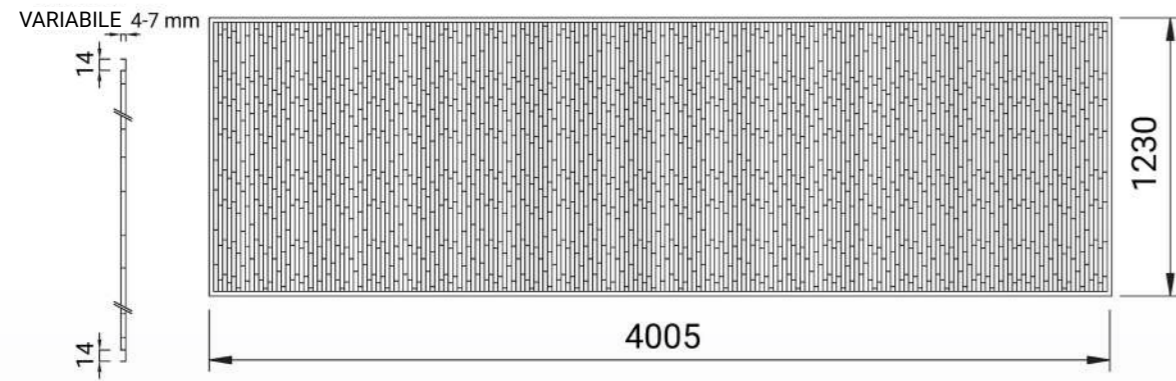

Dettaglio del getto

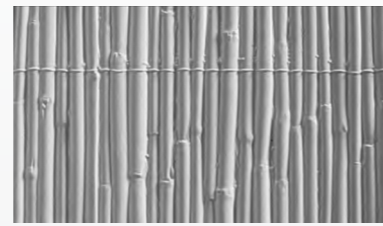

Dettaglio del getto

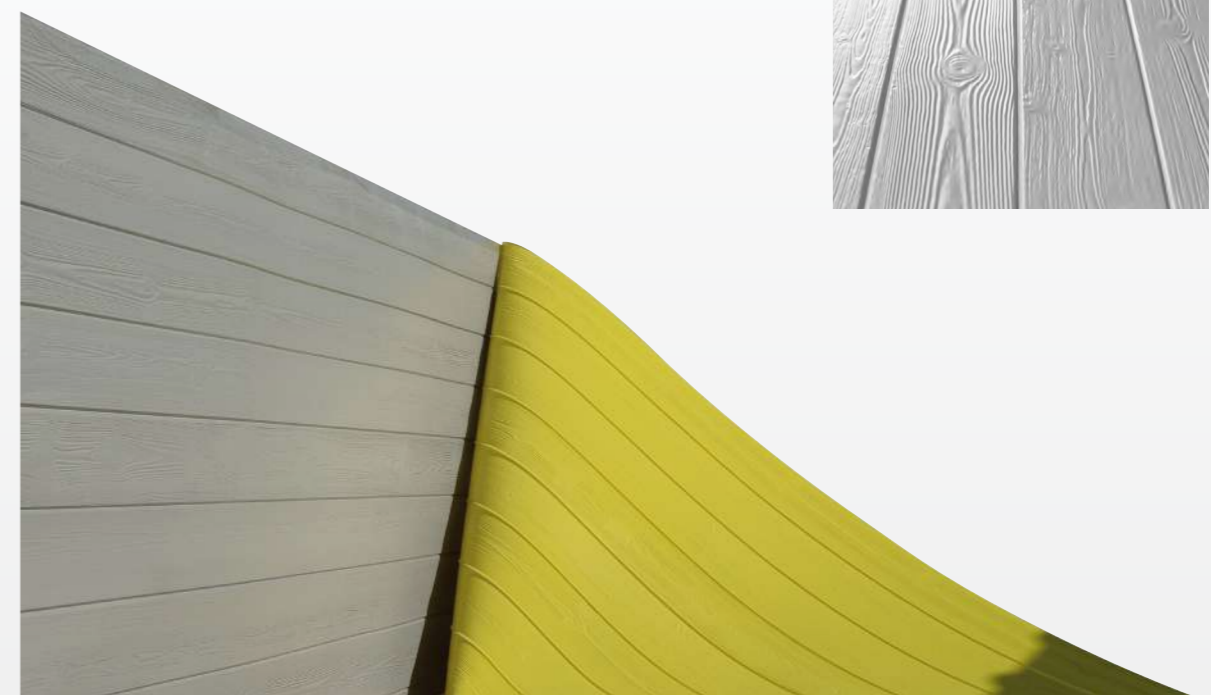
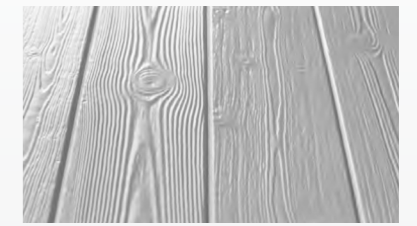

Wood collection

Wood collection

MOD. w15

MOD. w16

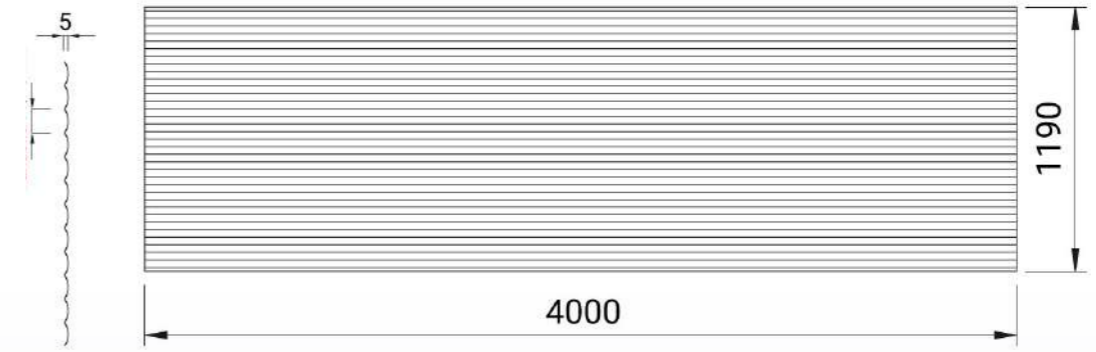
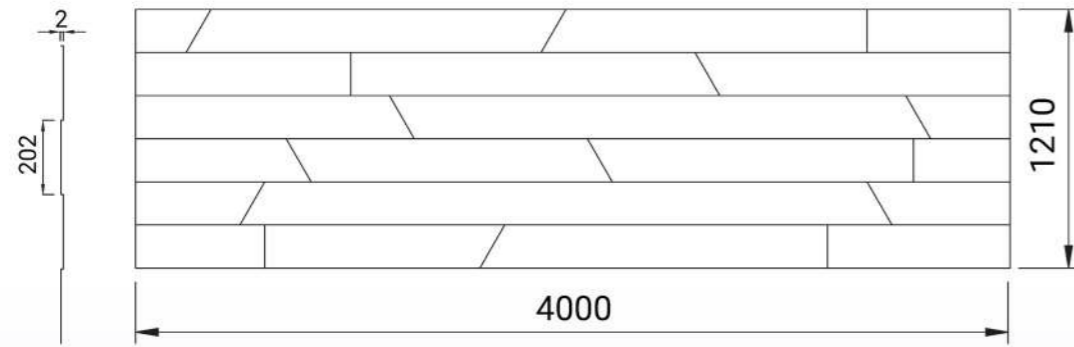

Dettaglio del getto



Dettaglio del getto



Wood collection

Wood collection

MOD. w74

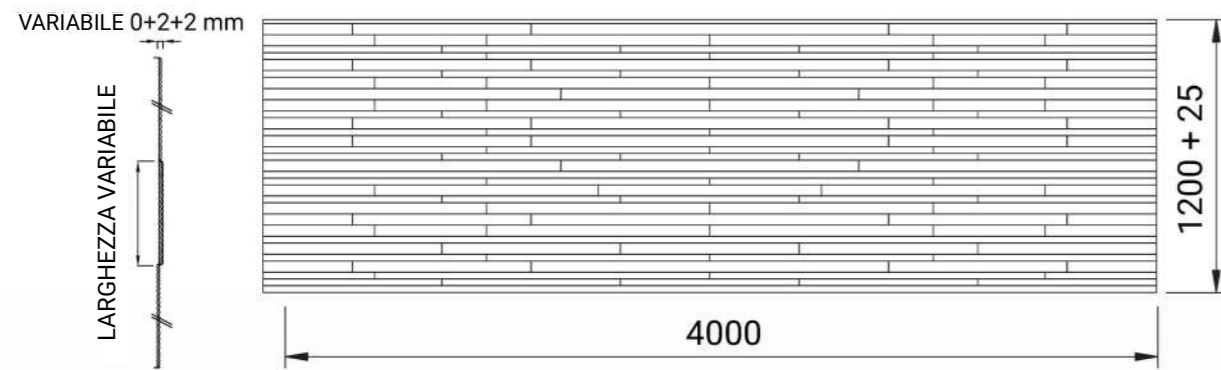

Dettaglio del getto

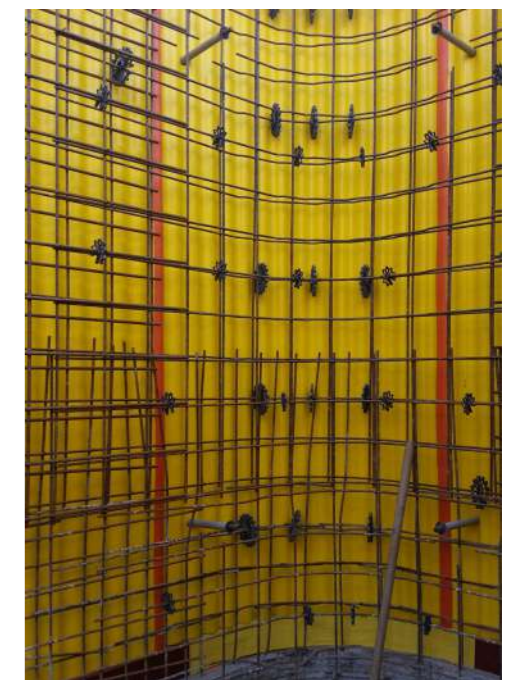
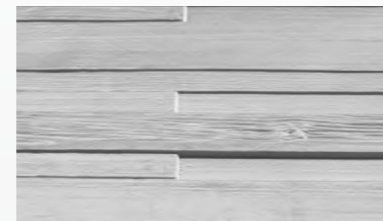

Wood collection

MOD. F21

MOD. F22

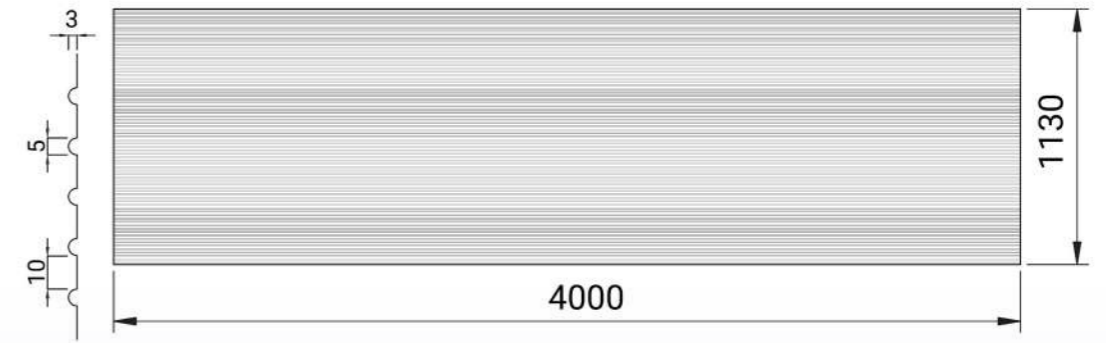
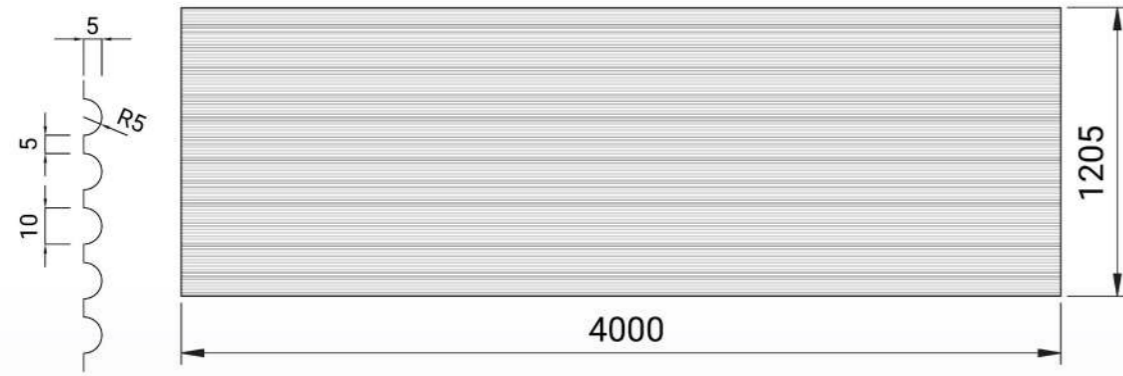

Dettaglio del getto

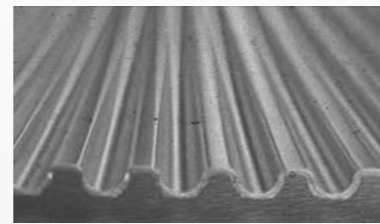

Dettaglio del getto

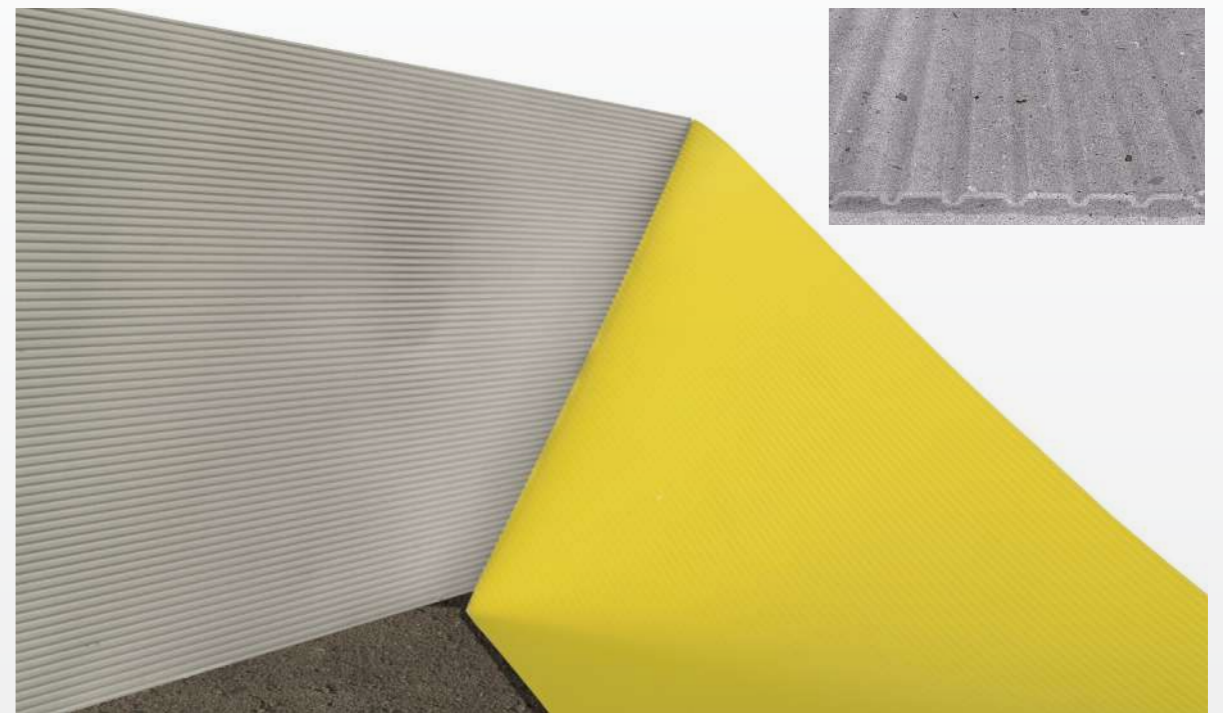
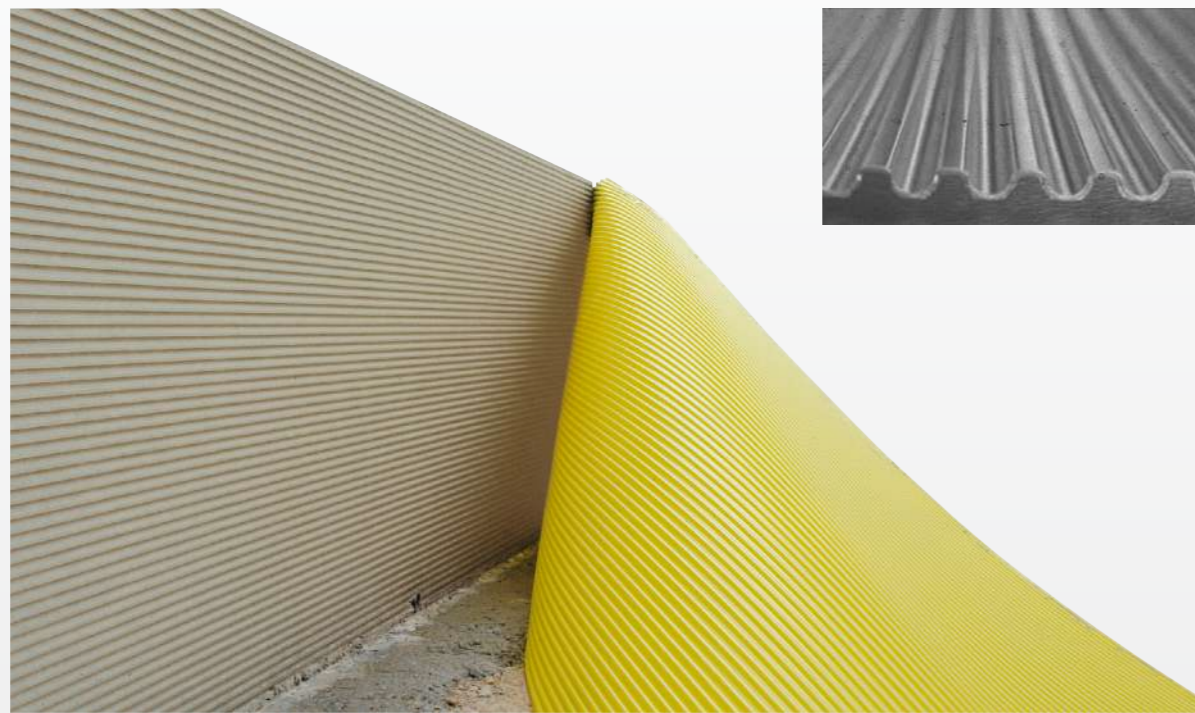
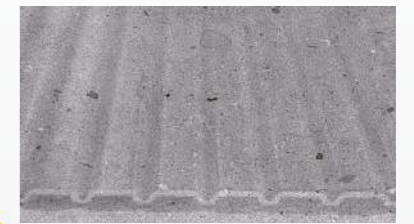

Form collection

Form collection

MOD. F23

MOD. F28

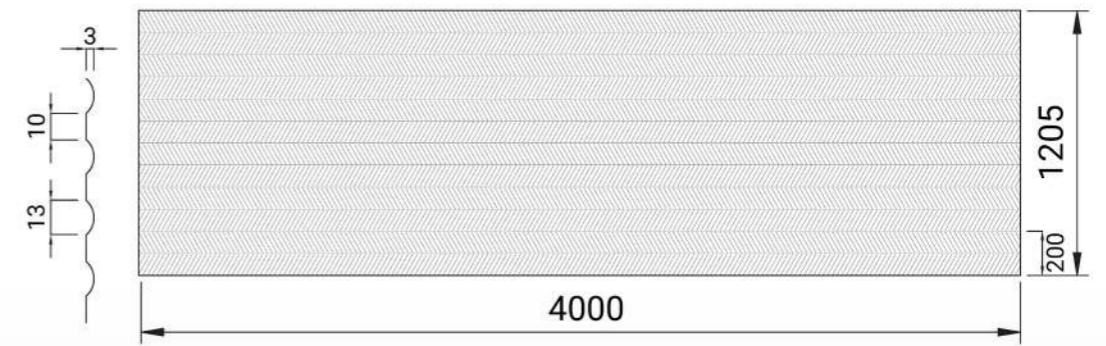
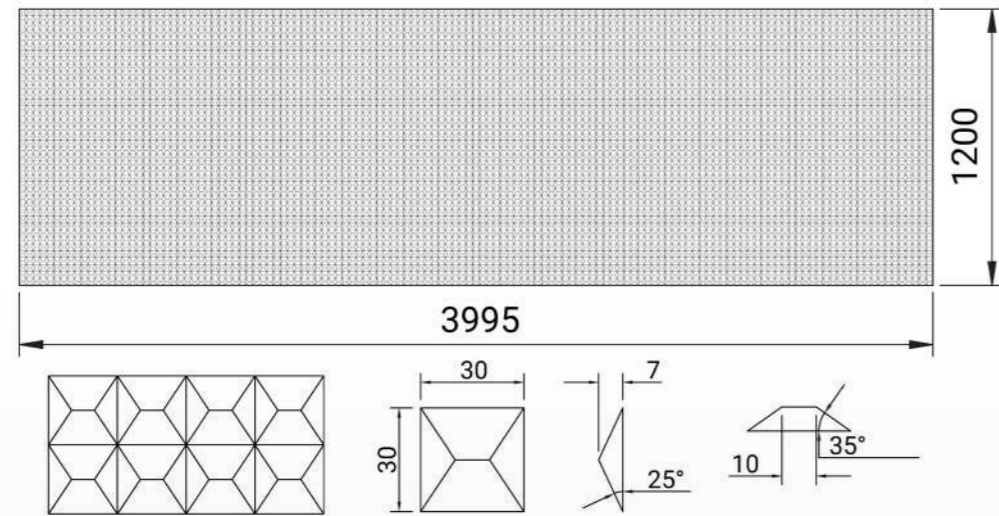

Dettaglio del getto

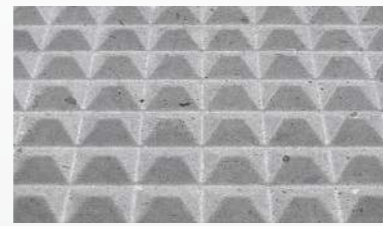

Dettaglio del getto

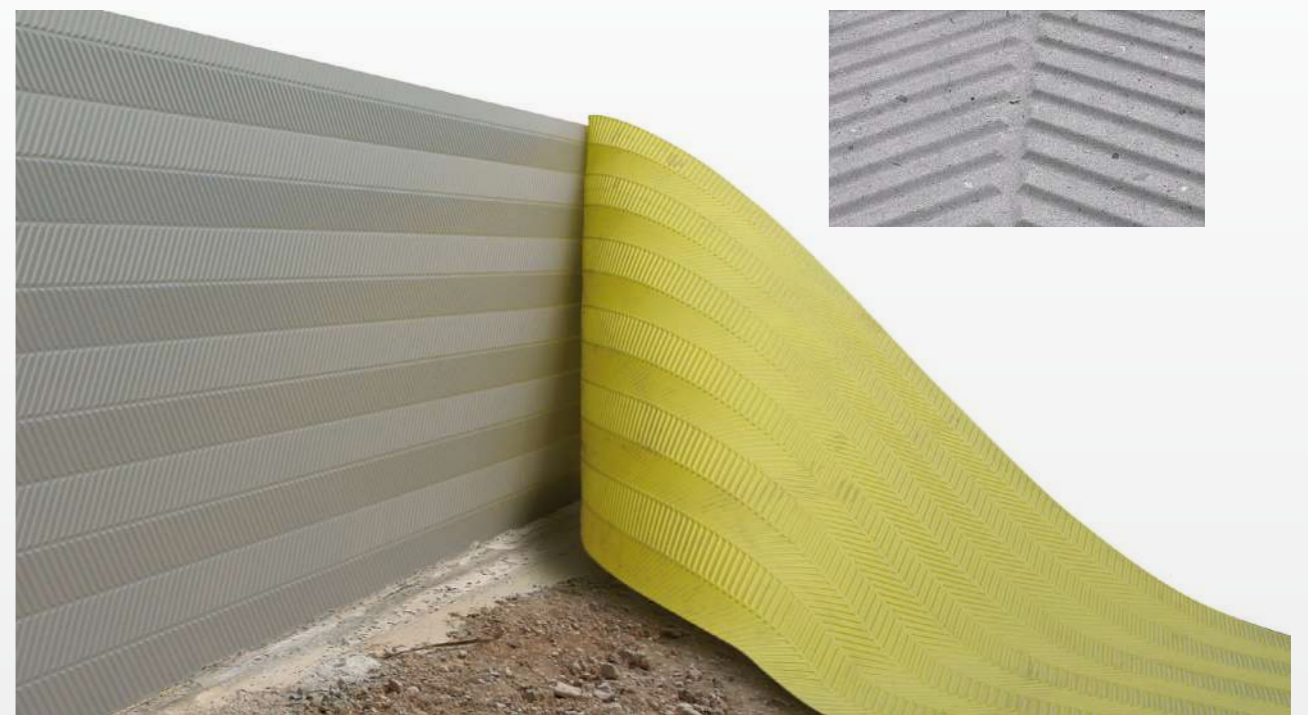
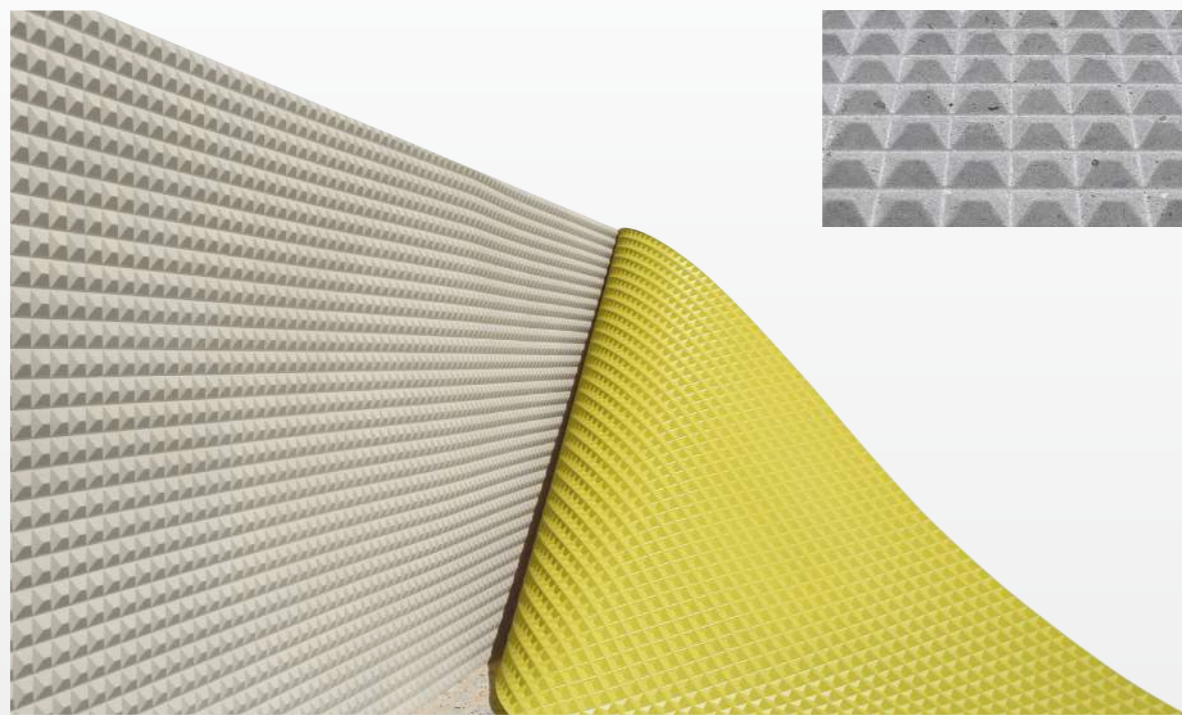

Form collection

Form collection

MOD. F29

MOD. F30

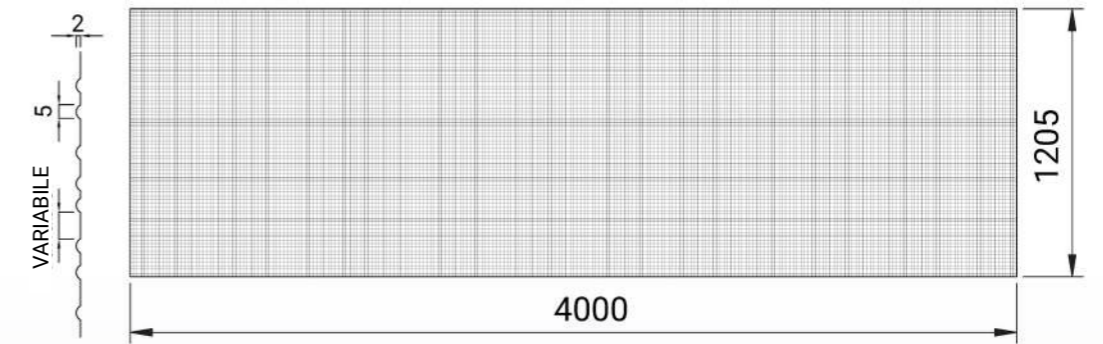
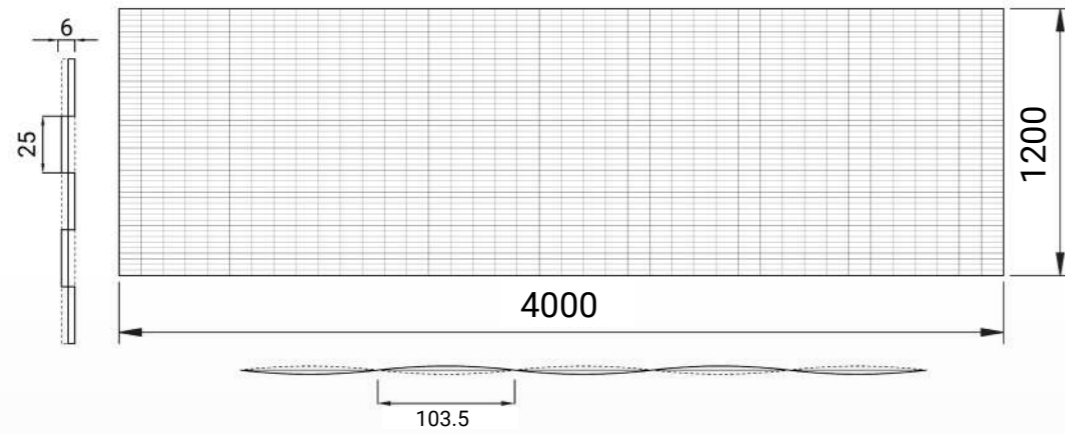

Dettaglio del getto

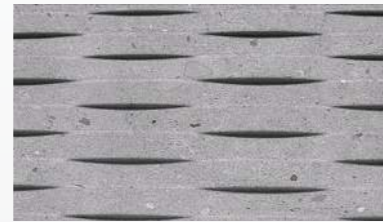

Dettaglio del getto

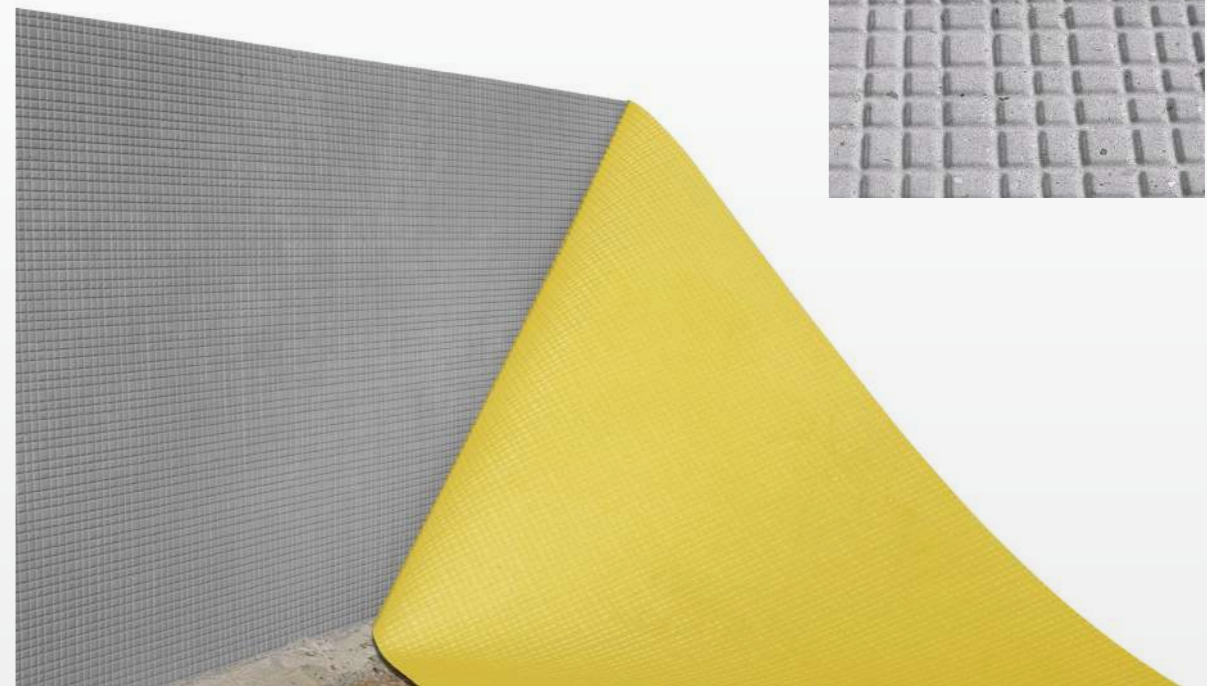

Form collection

Form collection

MOD. F31

MOD. F34

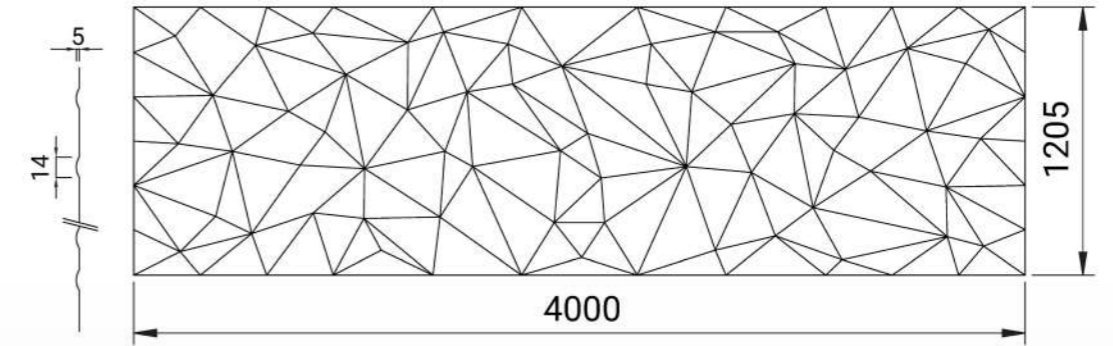
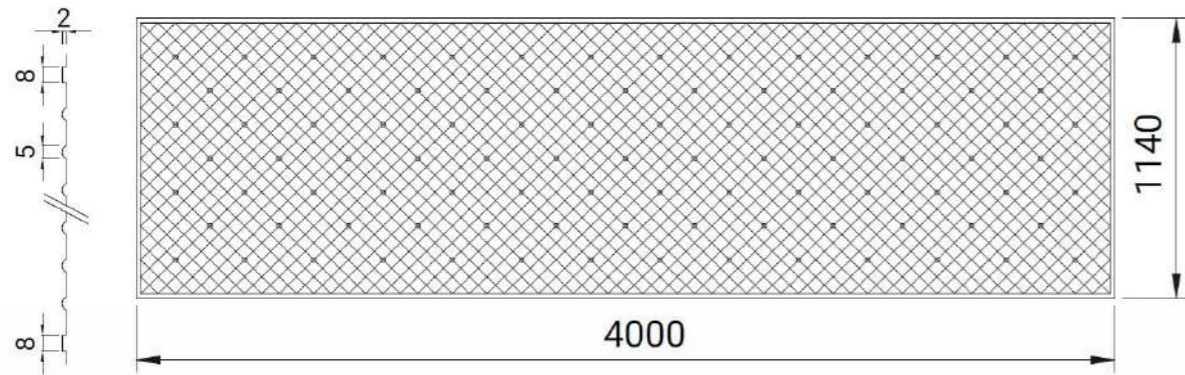

Dettaglio del getto

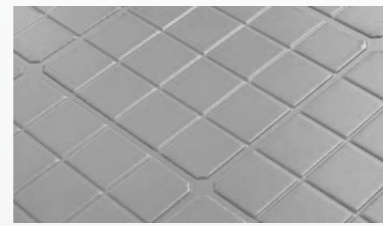

Dettaglio del getto

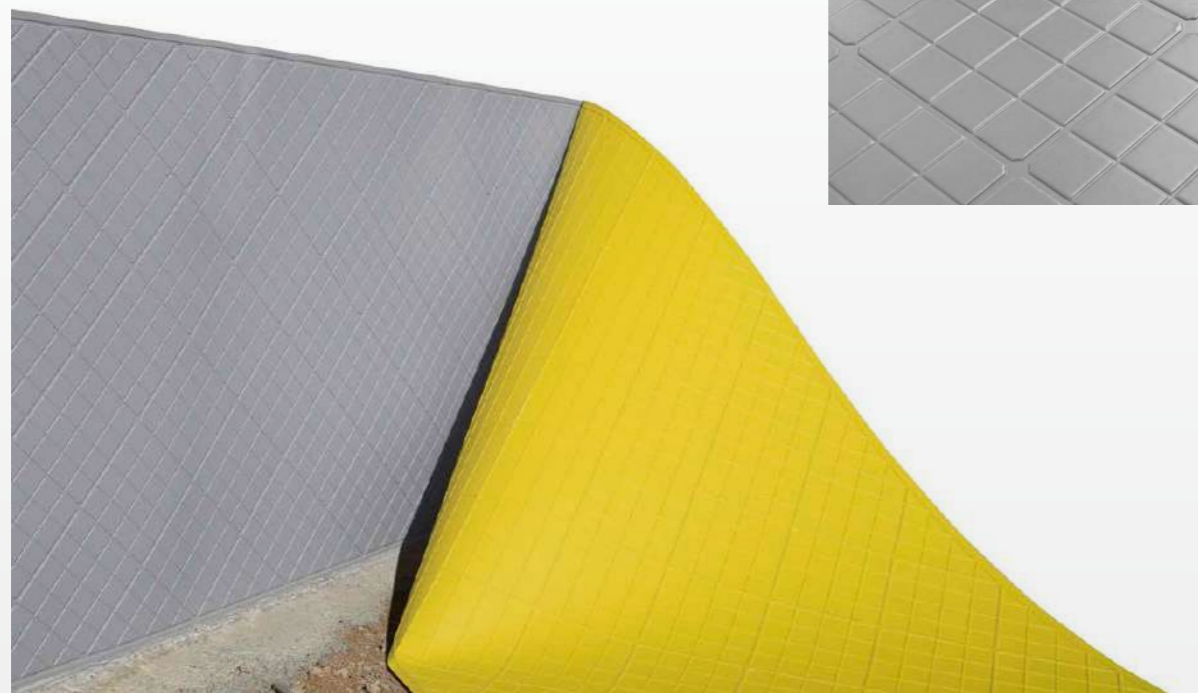
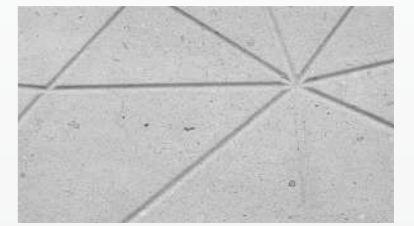

Form collection

Form collection

MOD. F35

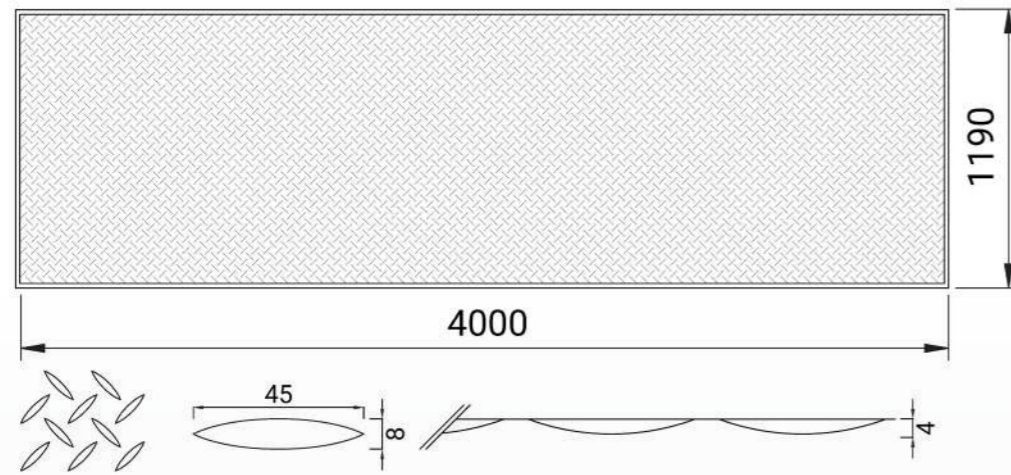

Dettaglio del getto

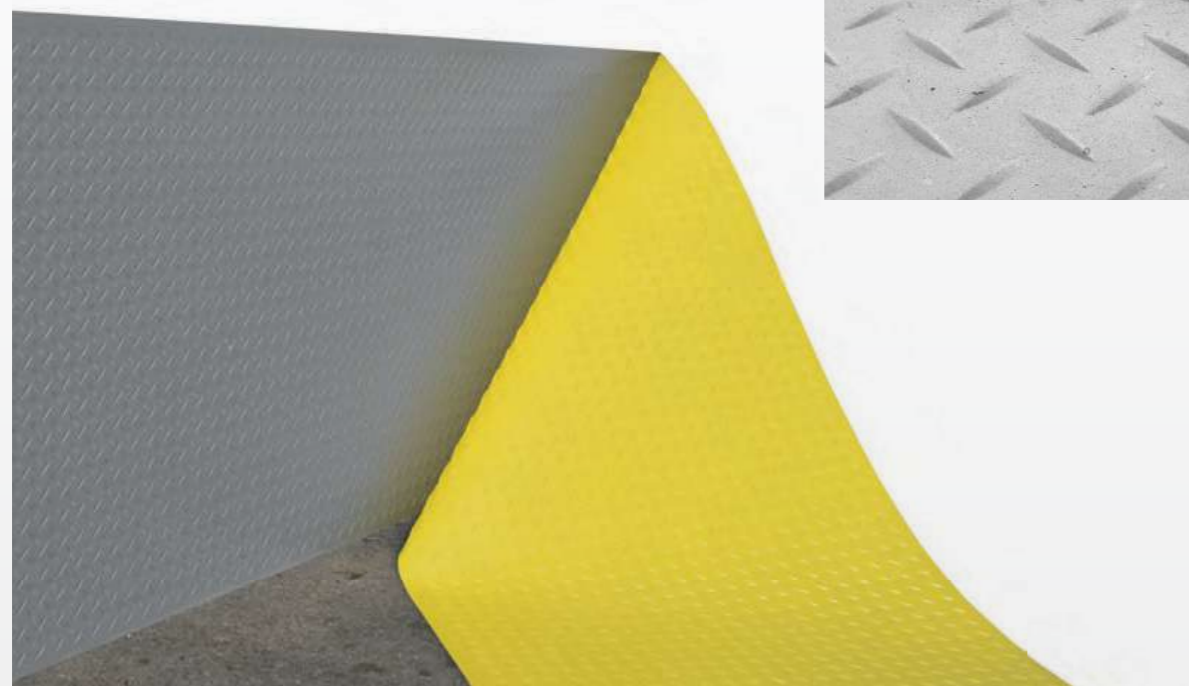

Form collection

MOD. F36

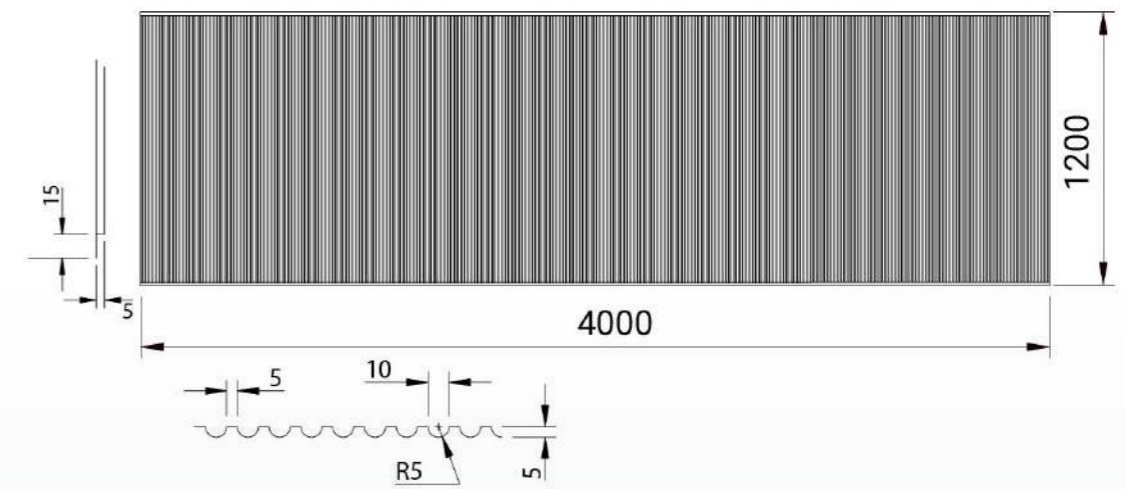

Dettaglio del getto

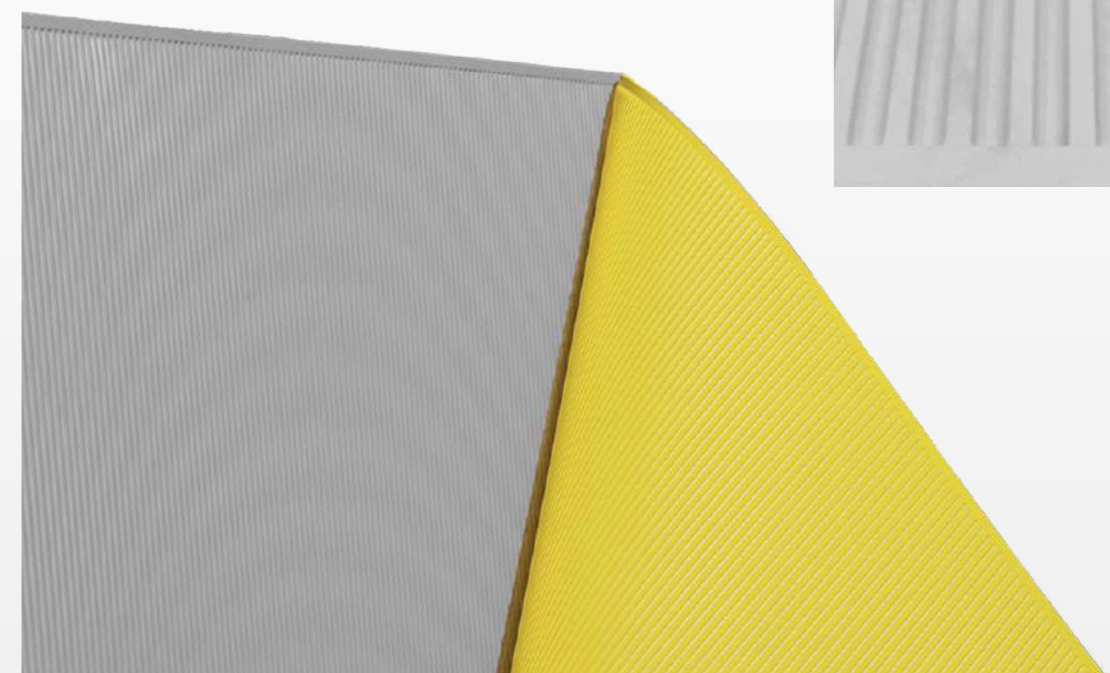
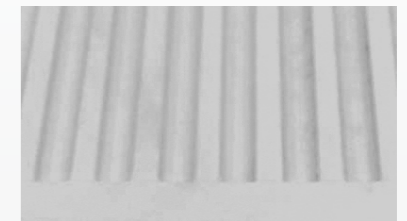

Form collection

MOD. F37

MOD. F61

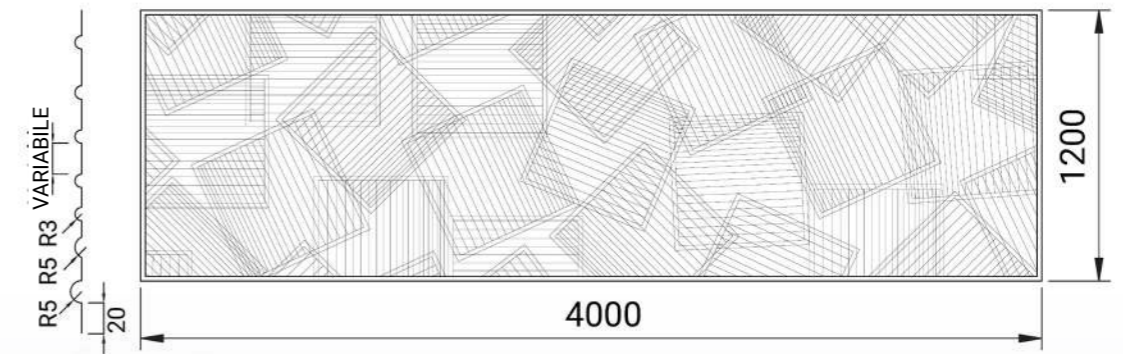
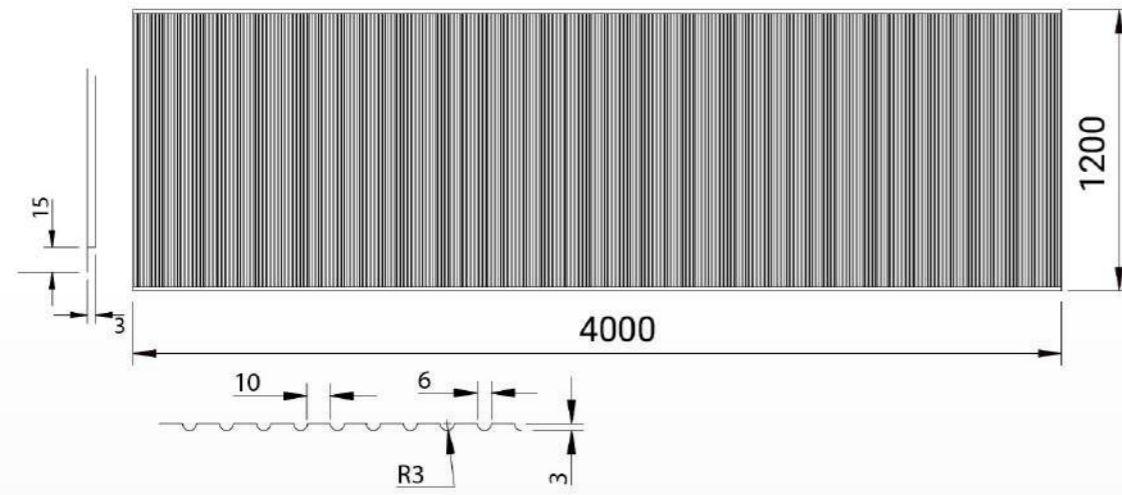

Dettaglio del getto

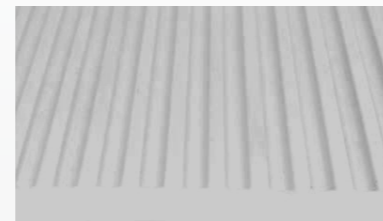

Dettaglio del getto

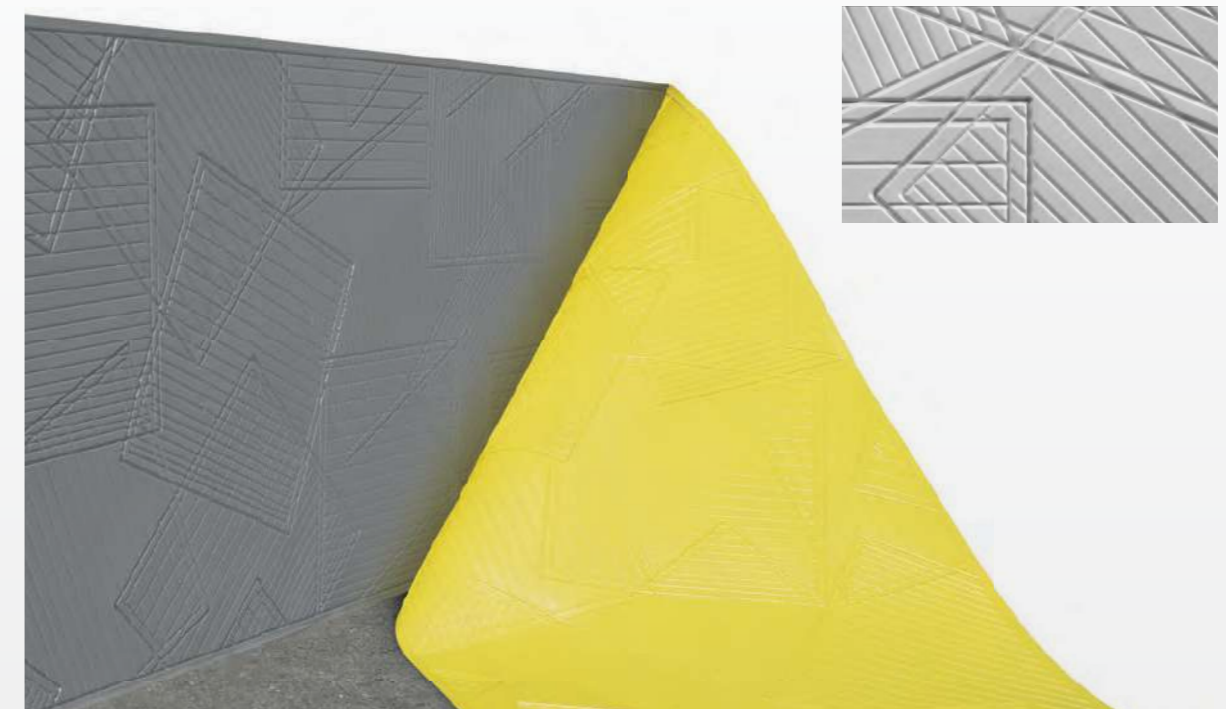
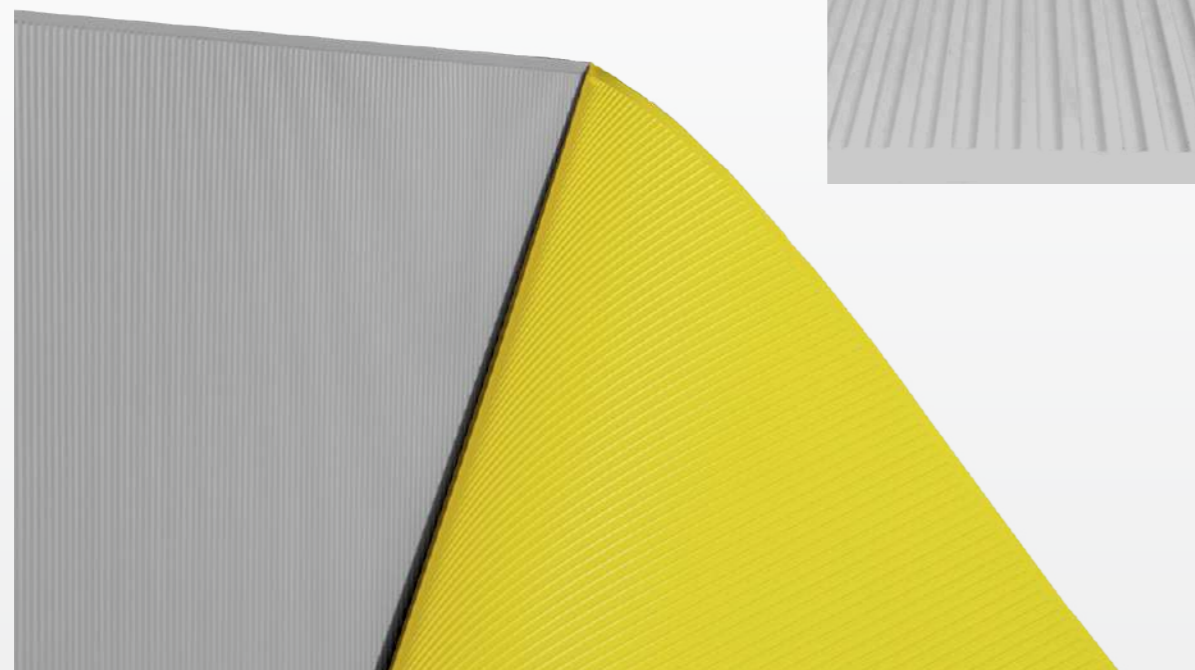

Form collection

Form collection

MOD. F66

MOD. F75

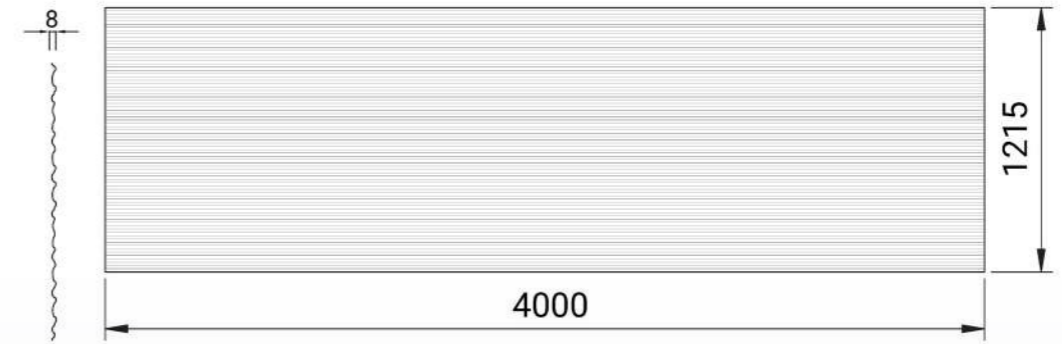
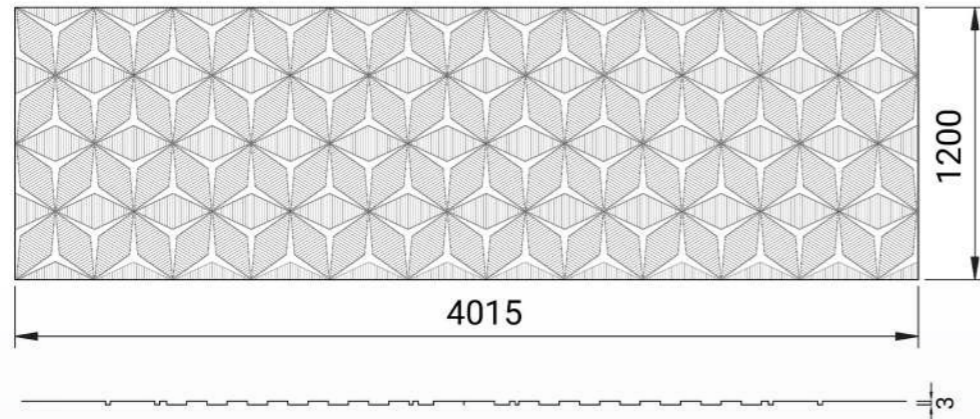

Dettaglio del getto



Dettaglio del getto

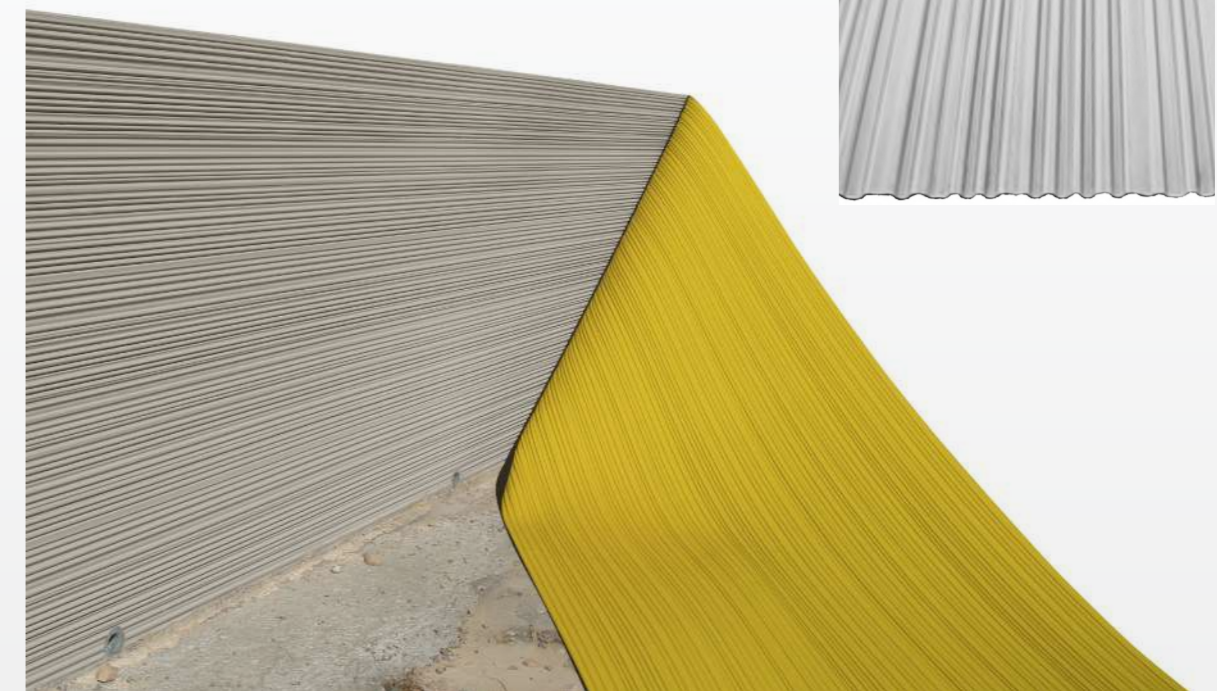
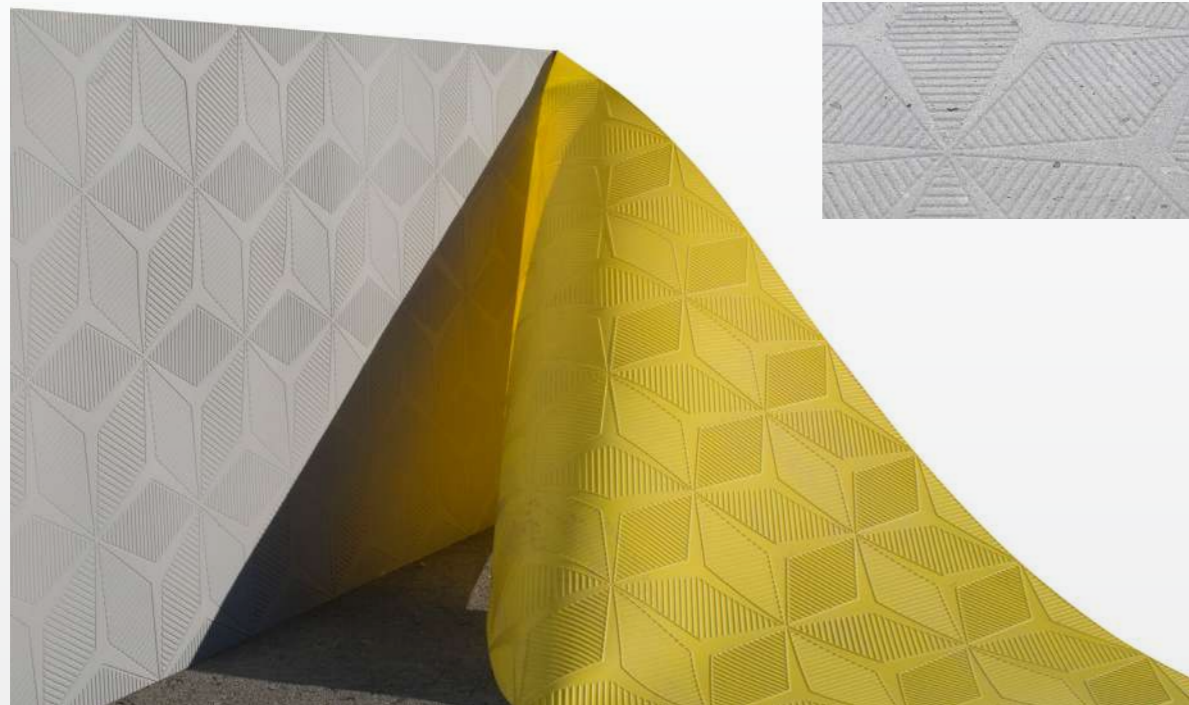

Form collection

Form collection

MOD. F77

MOD. F85

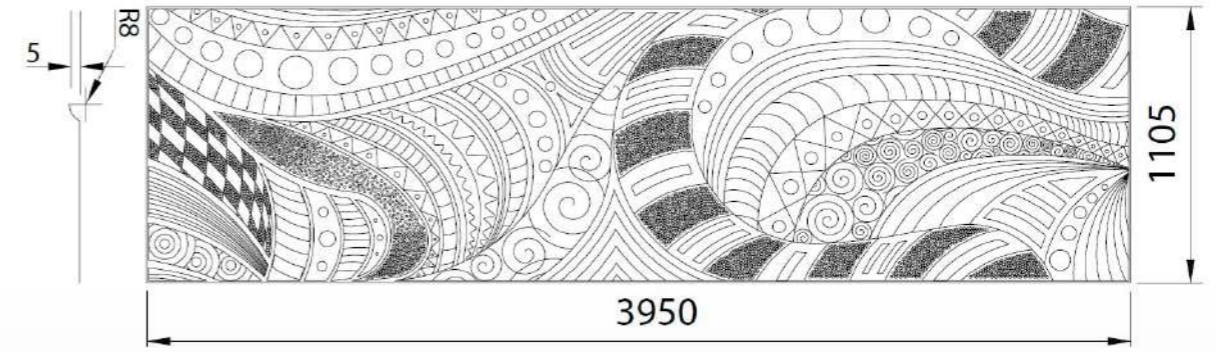
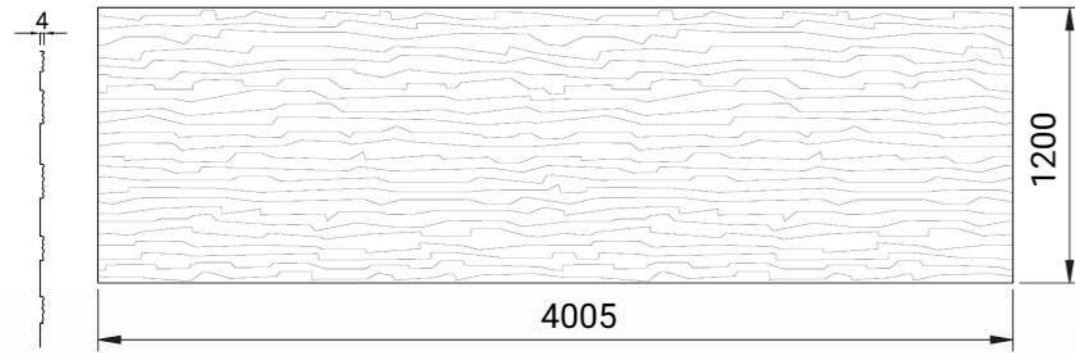

Dettaglio del getto



Dettaglio del getto

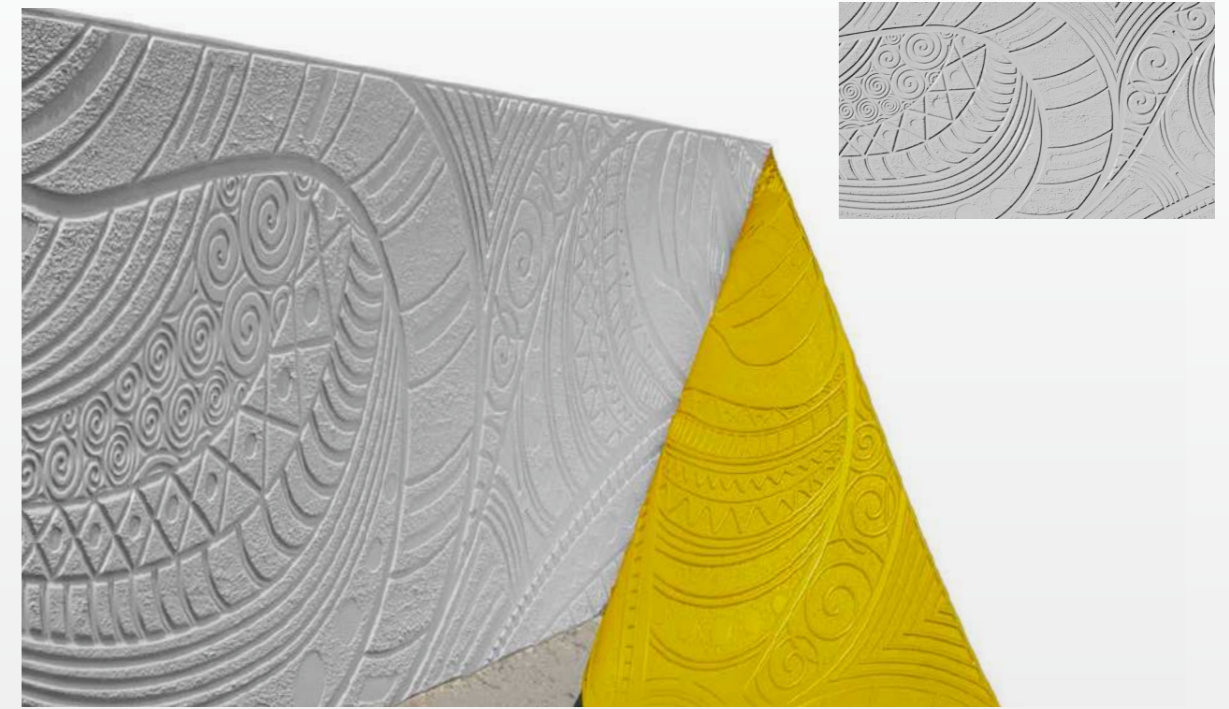
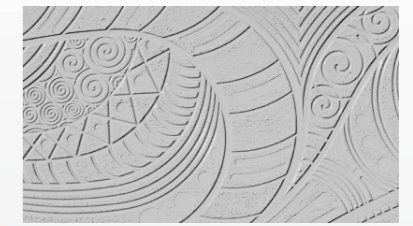

Form collection

Form collection

MOD. F86

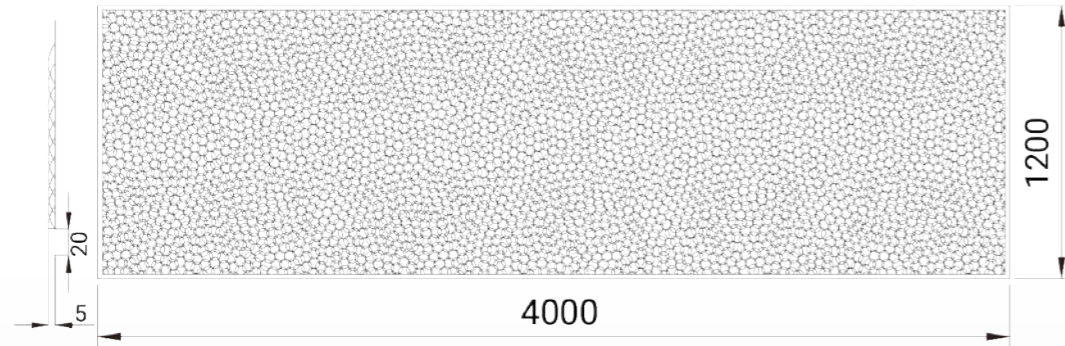

Dettaglio del getto

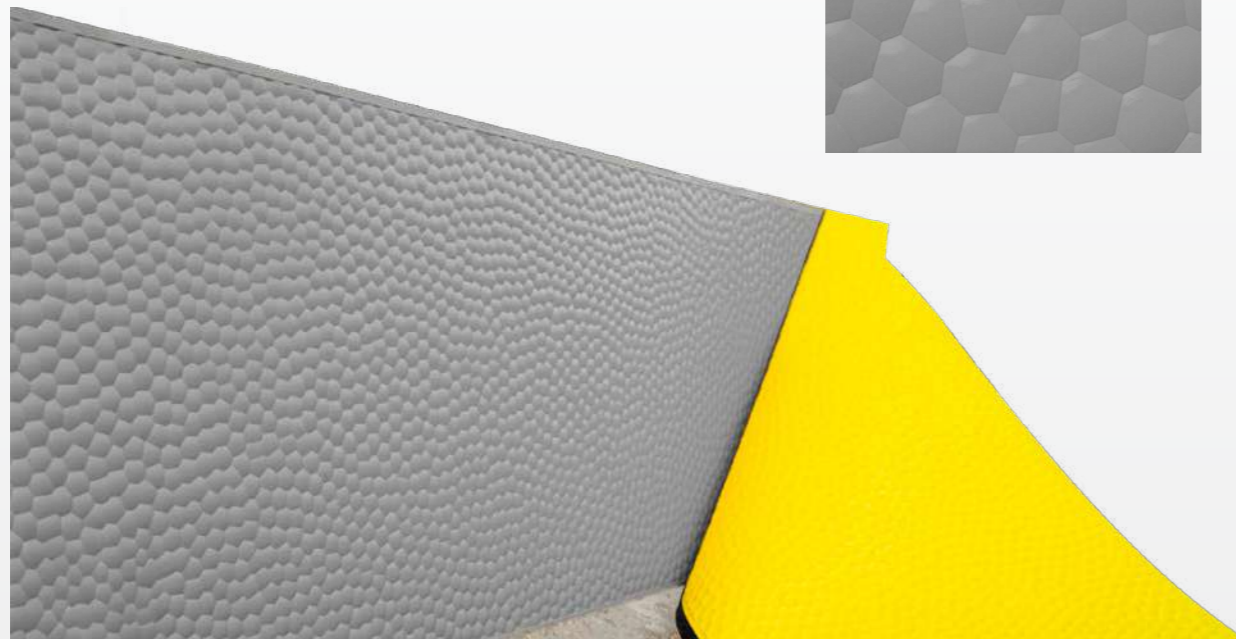
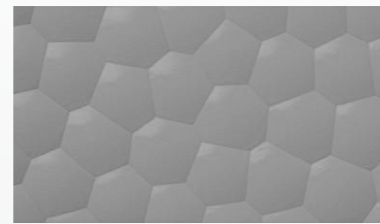

Form collection

MOD. F88

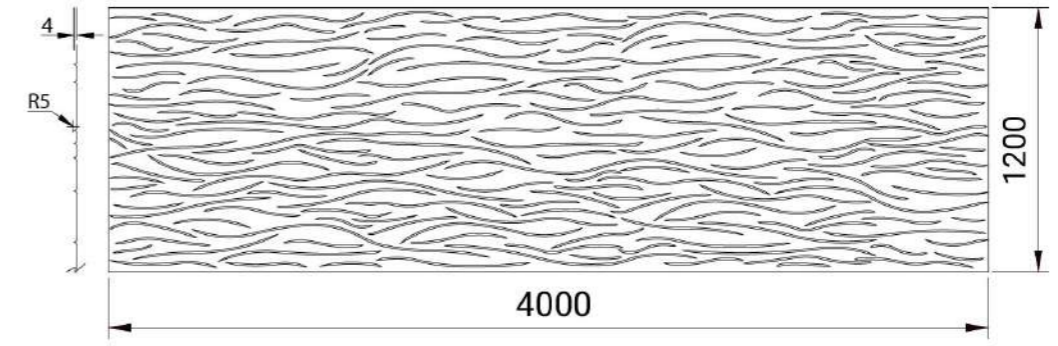

Dettaglio del getto

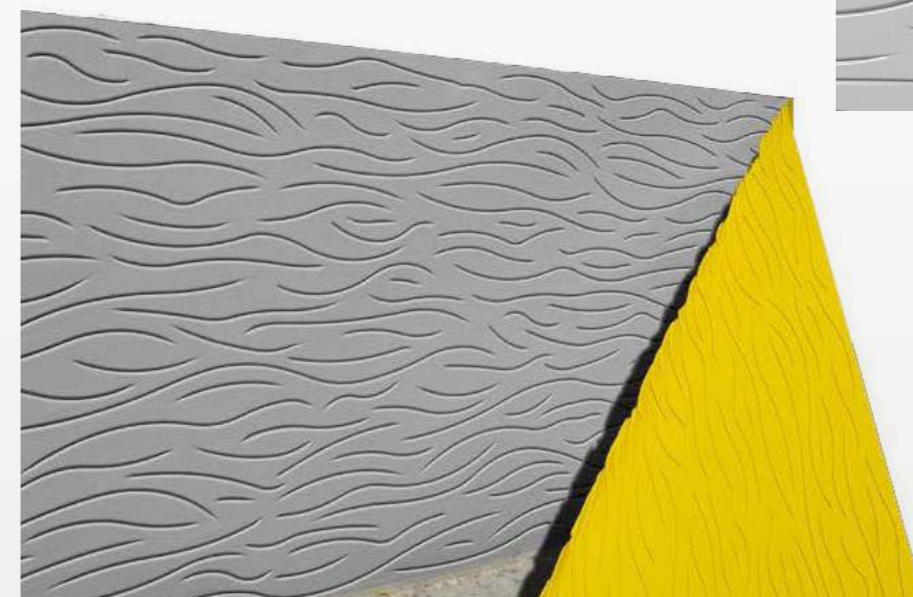
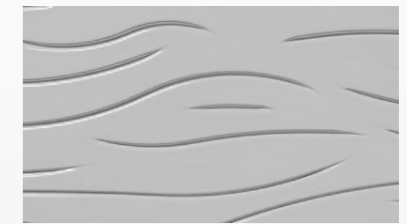

Form collection

MOD. s51

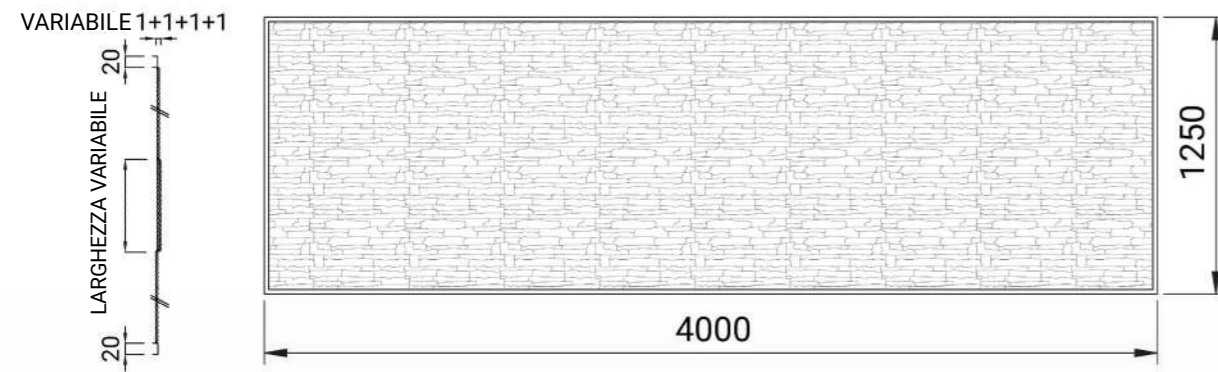

MOD. s53

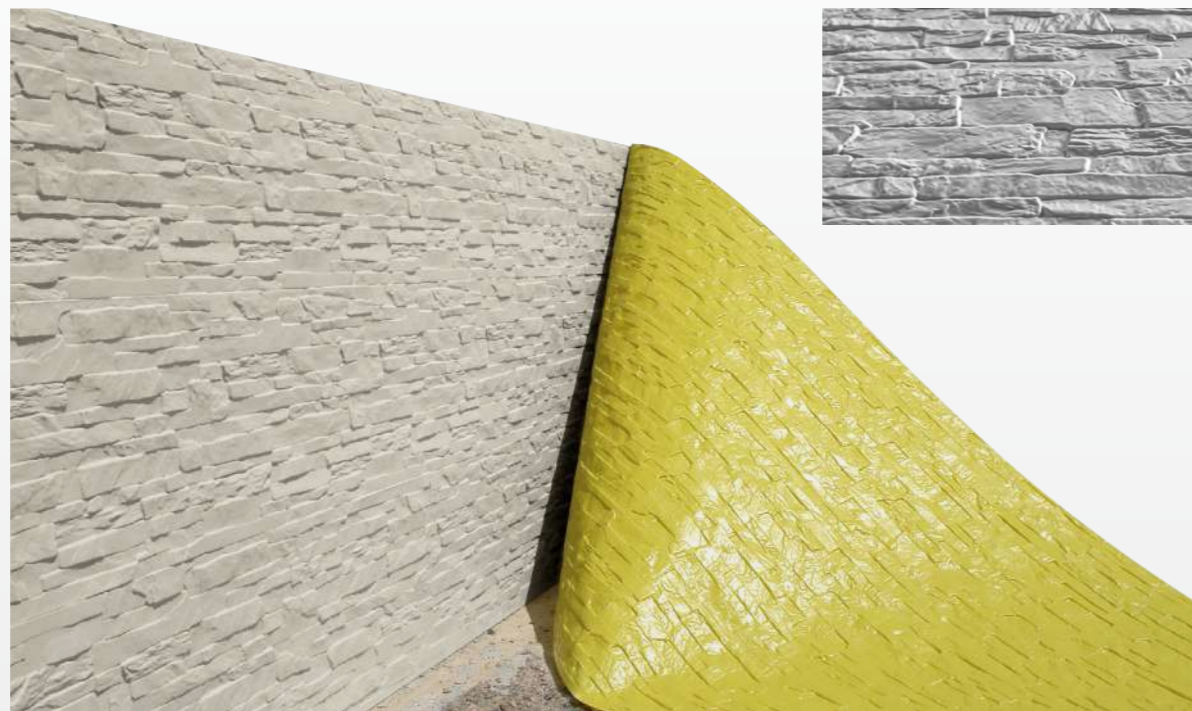
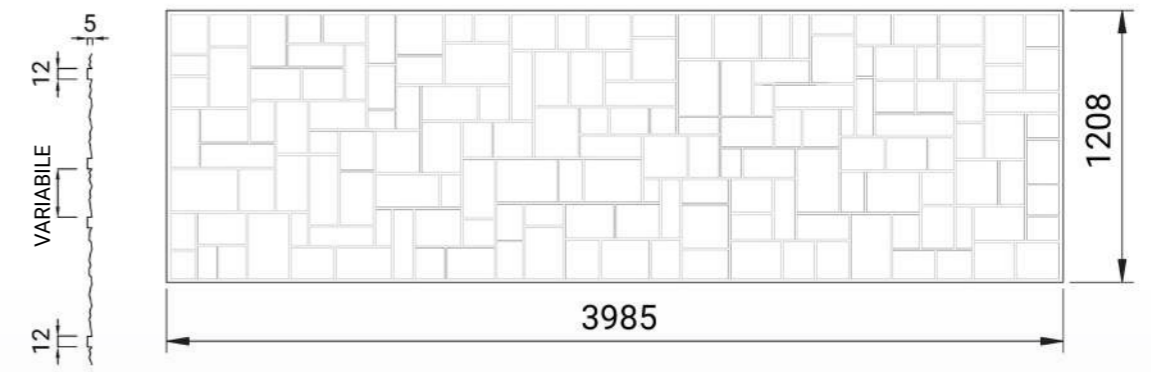

Stone collection

Stone collection

MOD. s54

MOD. s55

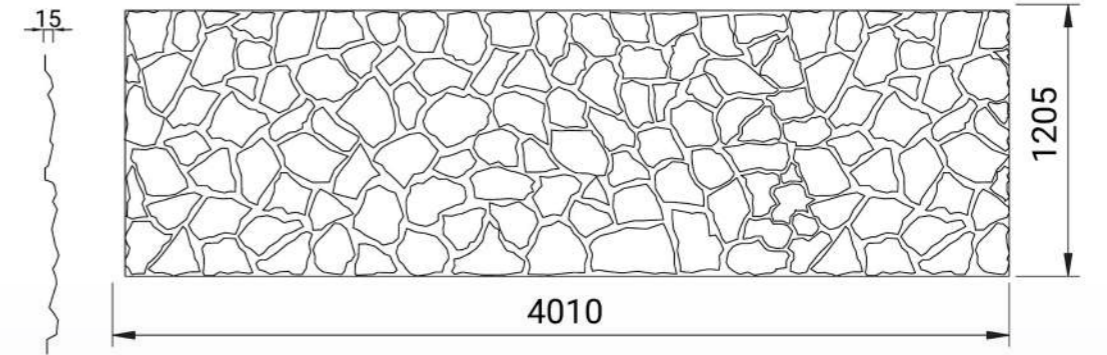
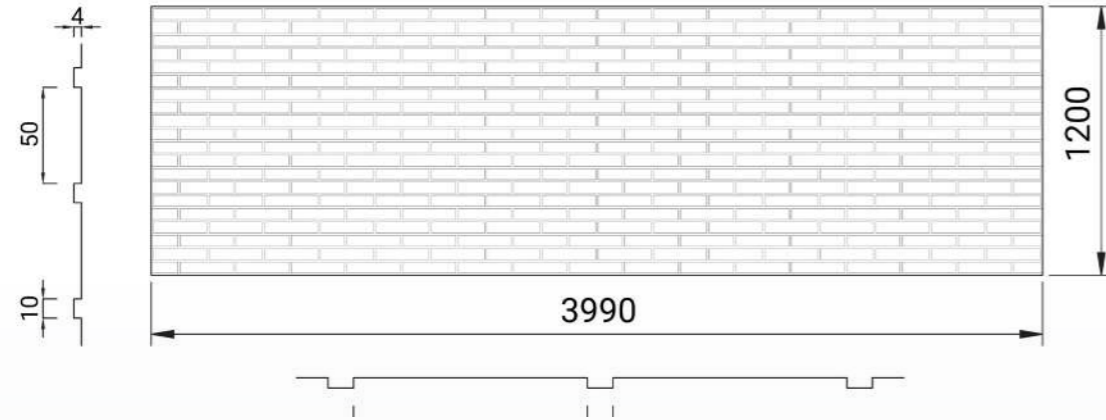

Dettaglio del getto

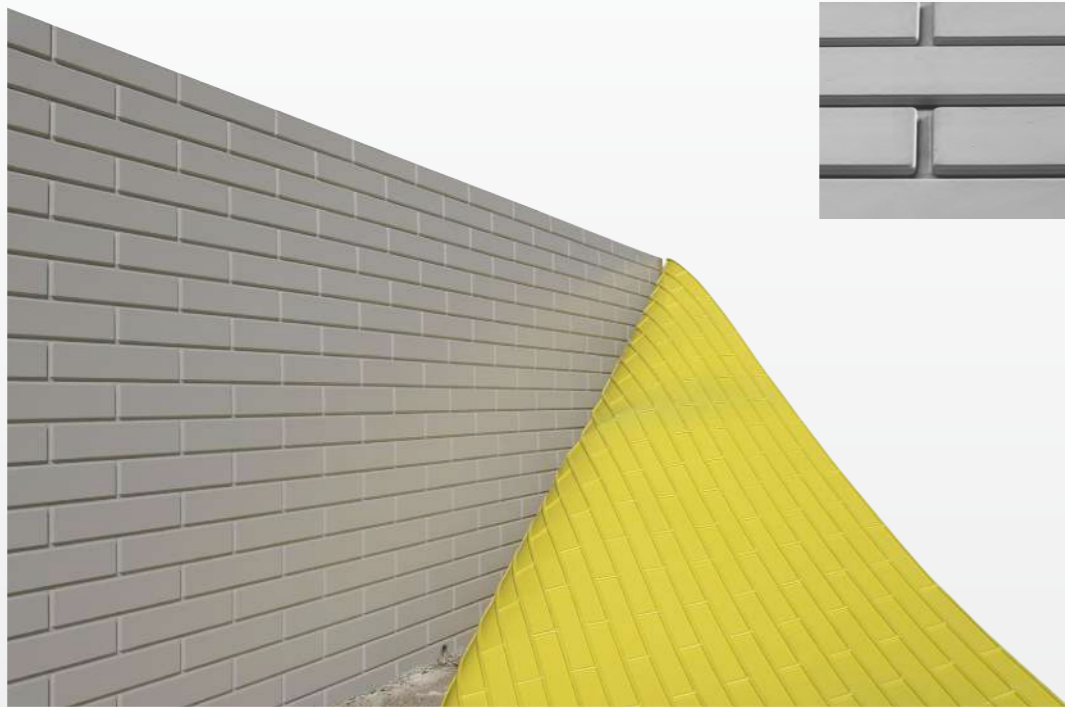

Stone collection

Dettaglio del getto

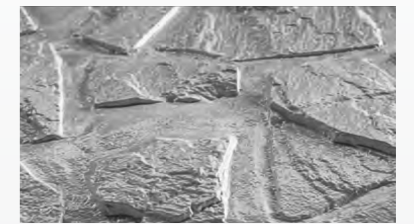

Stone collection

MOD. s56

MOD. s57

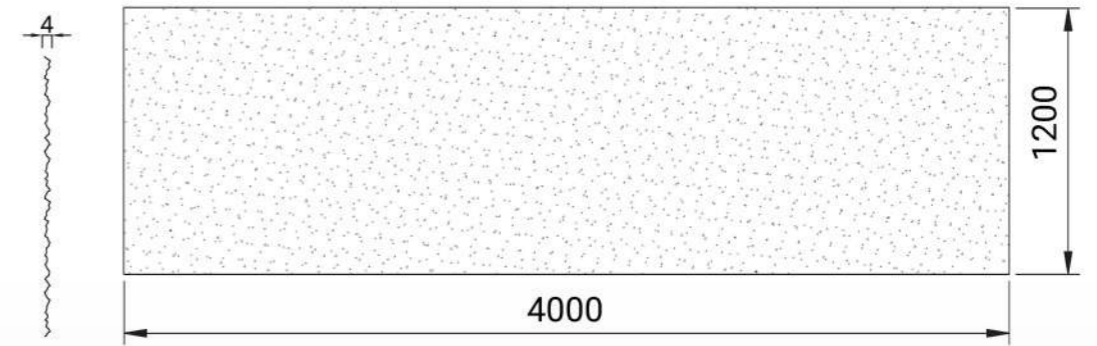
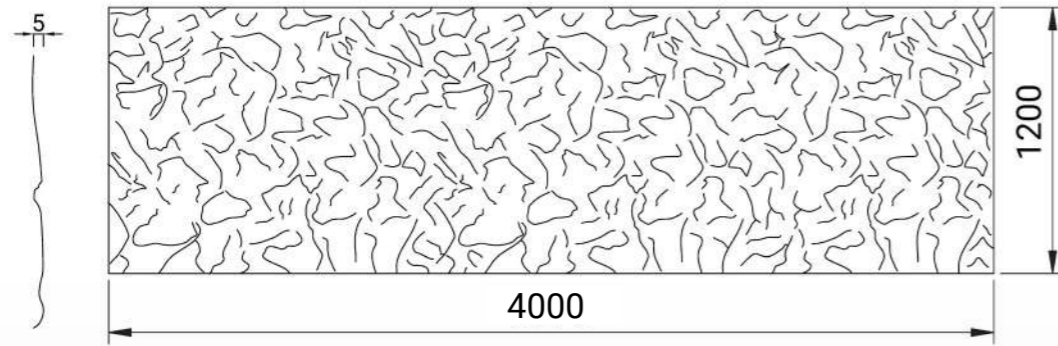

Dettaglio del getto

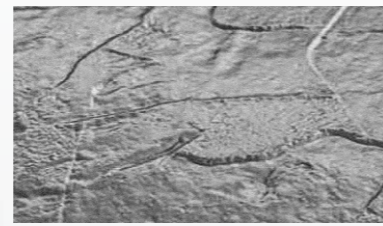

Dettaglio del getto



Stone collection

Stone collection

MOD. s58

MOD. s70

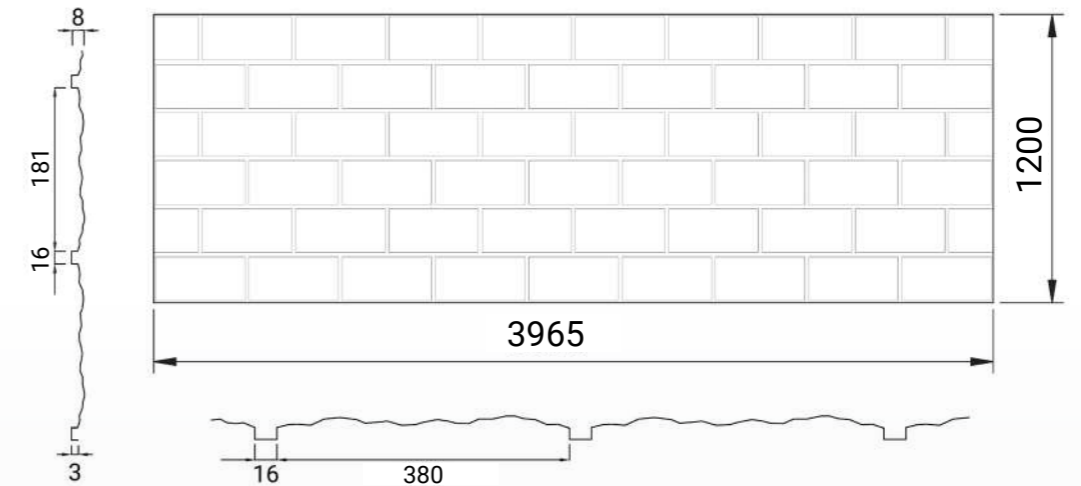
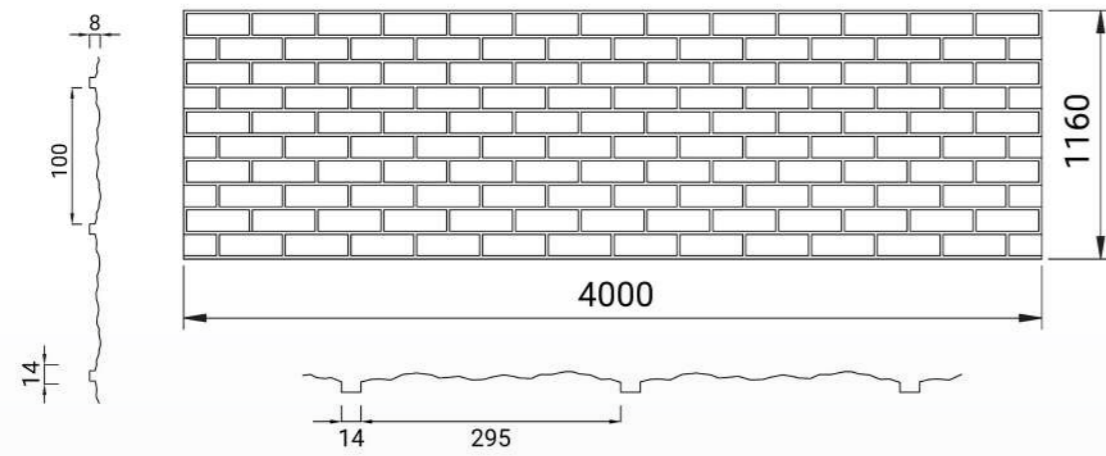

Dettaglio del getto



Dettaglio del getto

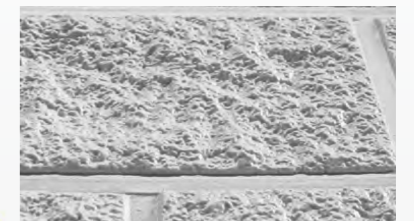

Stone collection

Stone collection

MOD. s76

MOD. s80

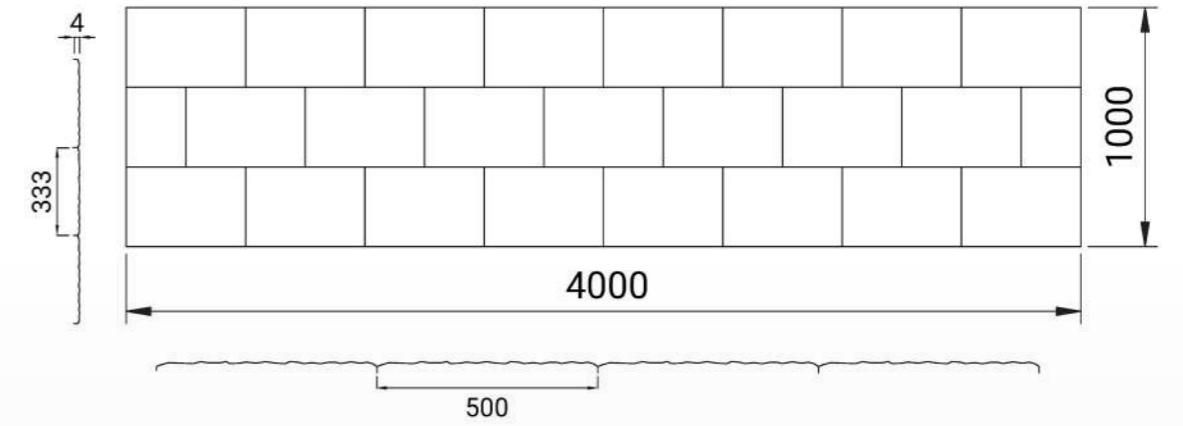
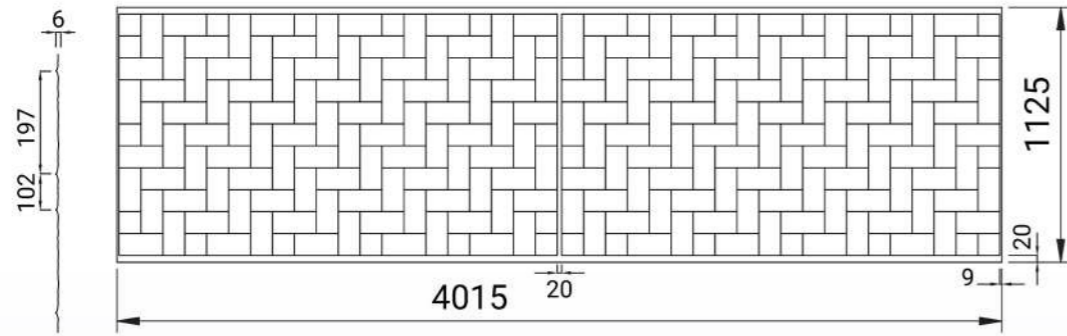

Dettaglio del getto

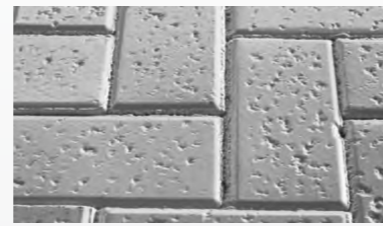

Dettaglio del getto

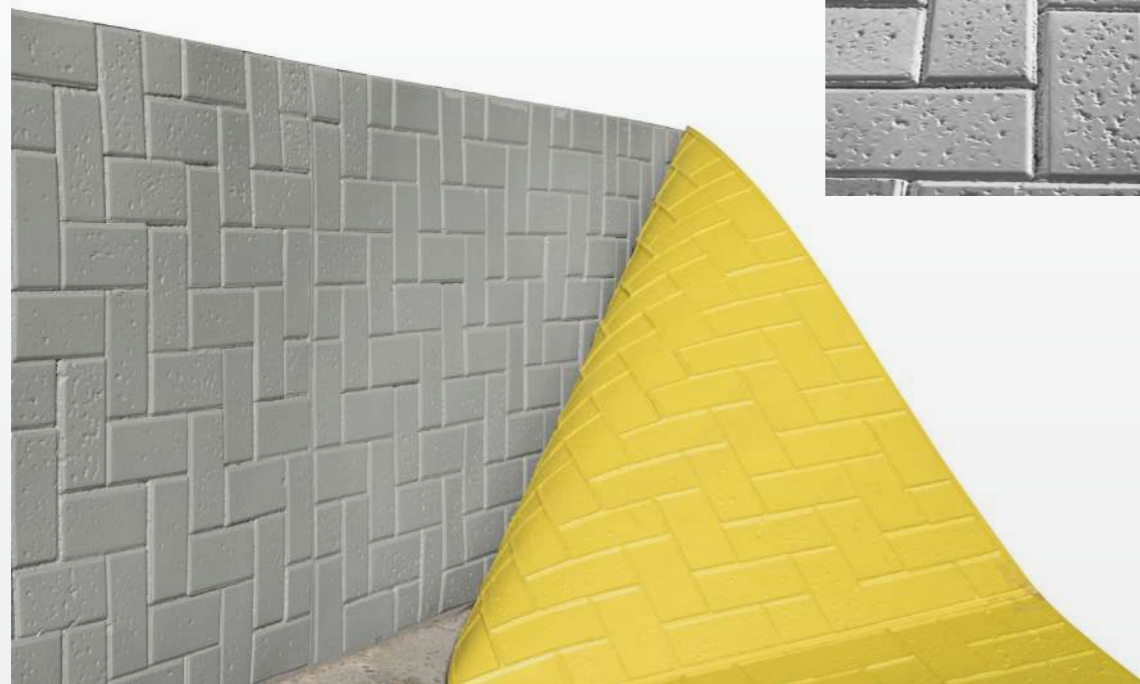

Stone collection

Stone collection

MOD. s81

MOD. s82

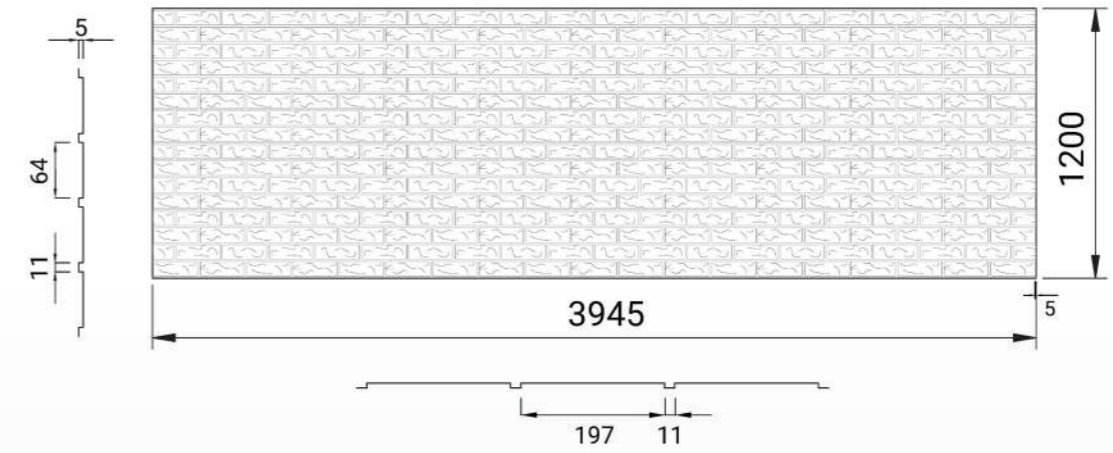
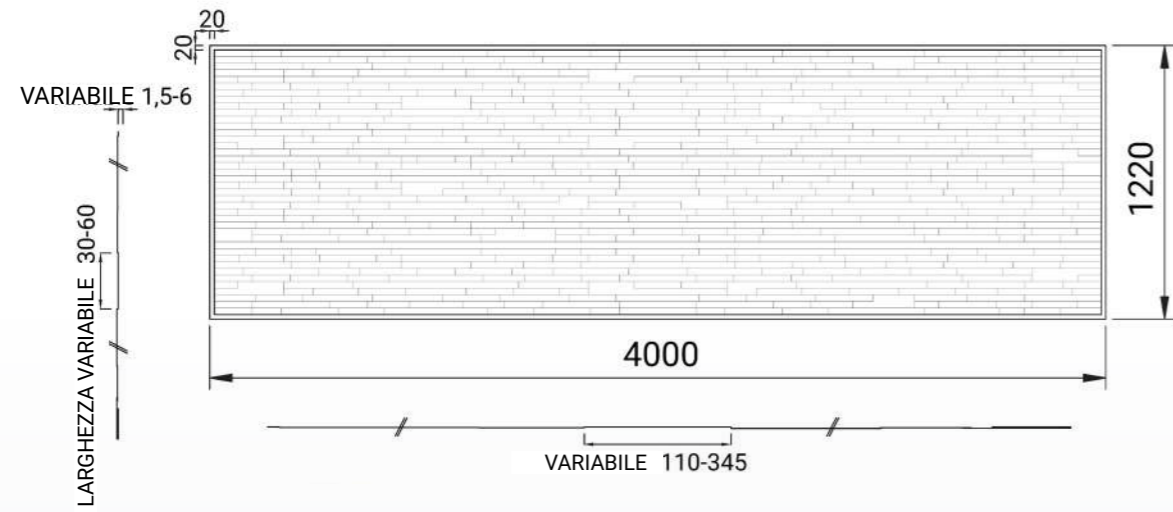

Dettaglio del getto

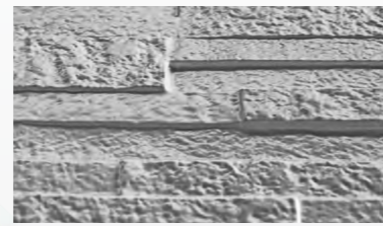

Dettaglio del getto

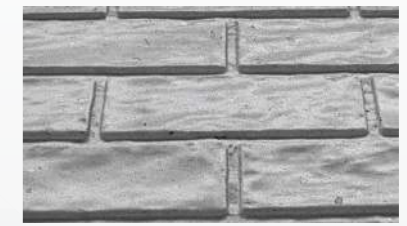

Stone collection

Stone collection

MOD. s83

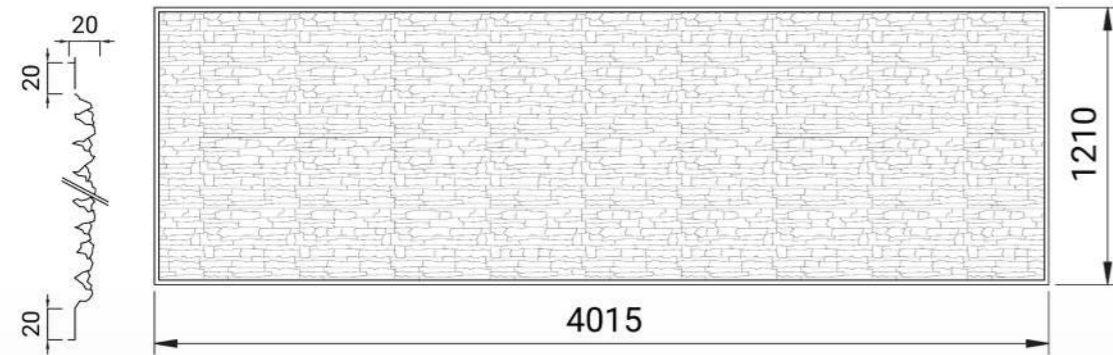

Dettaglio del getto

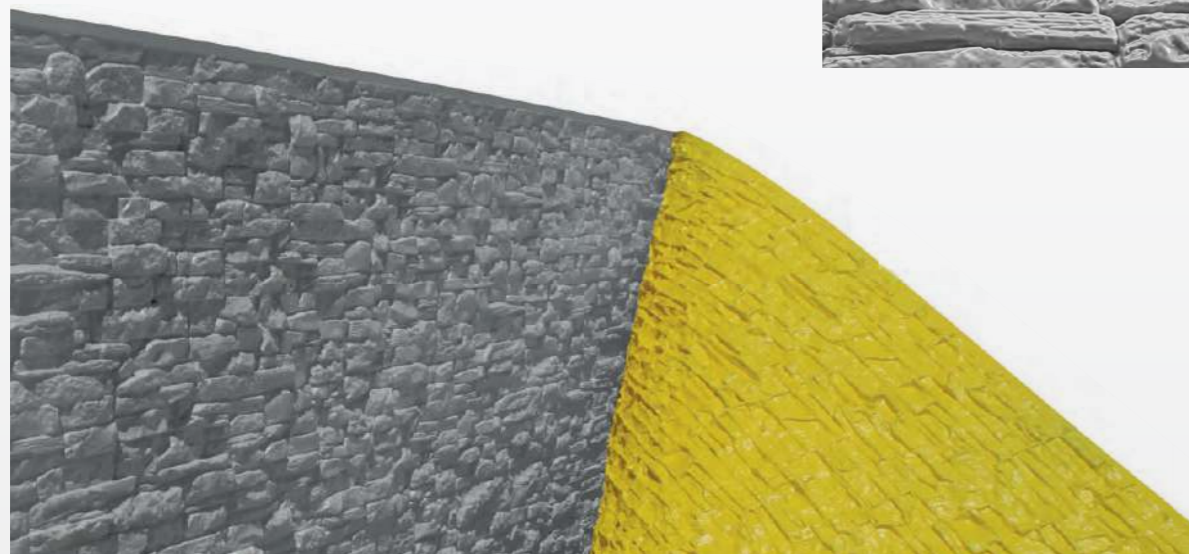
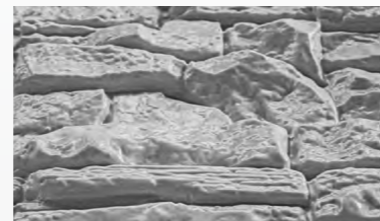

Stone collection

MOD. s84

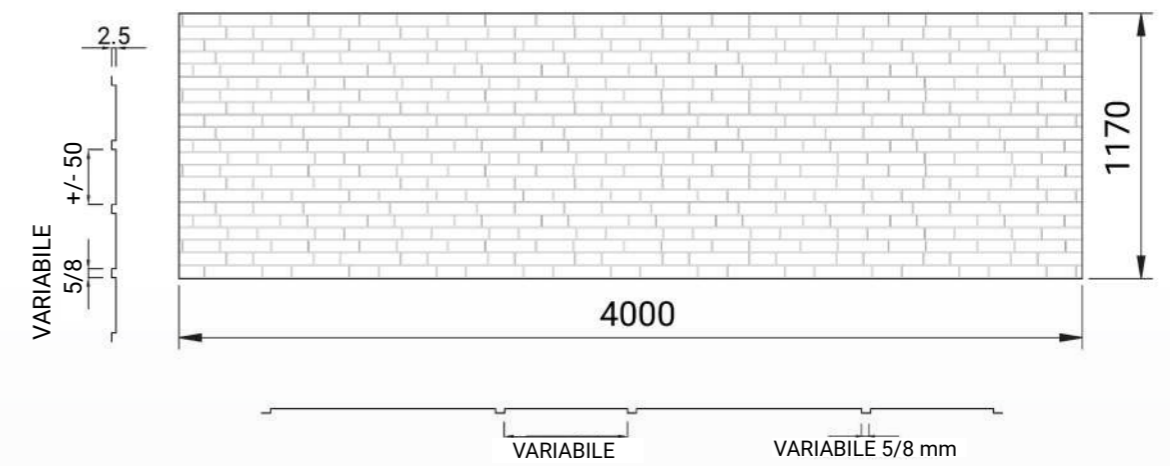

Dettaglio del getto

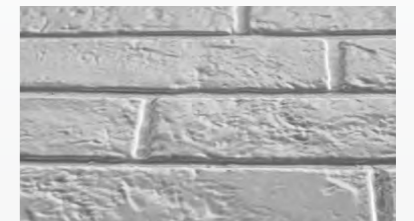

Stone collection

MOD. s87

MOD. L00

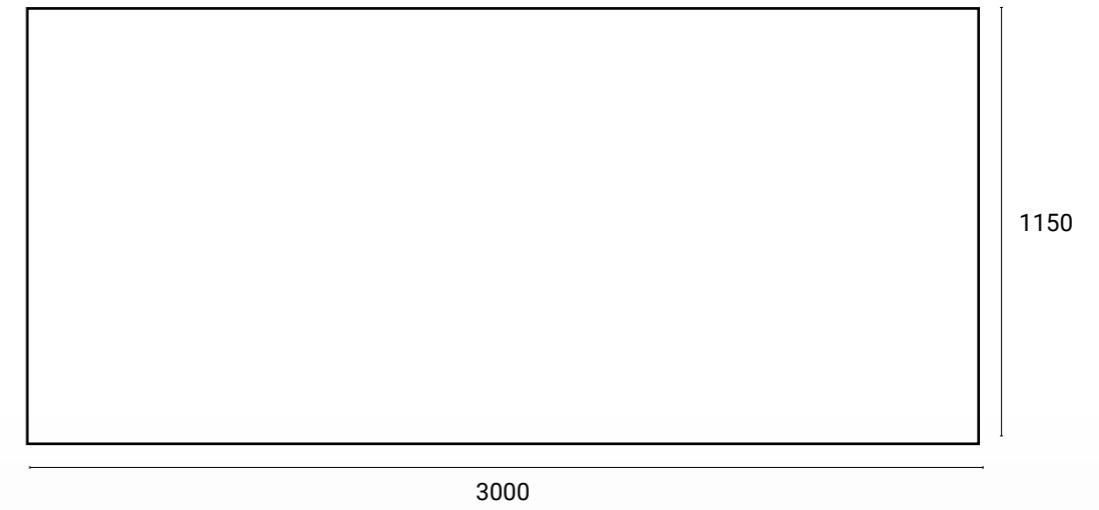
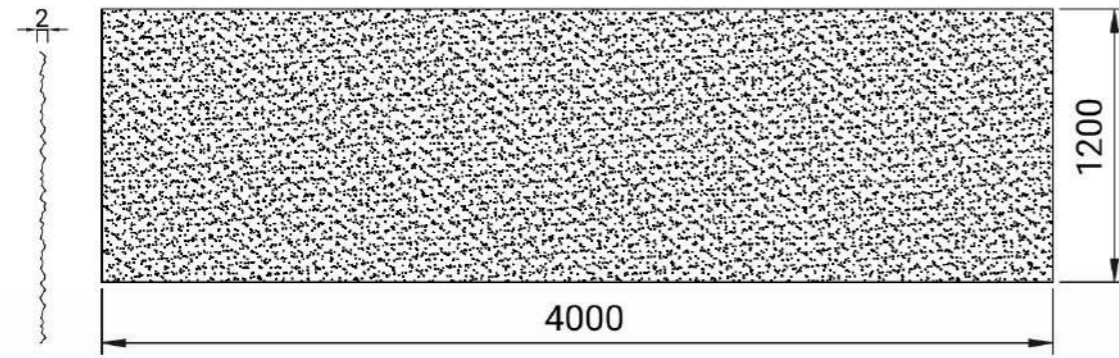

Pannello in MDF da 2,5 mm per getti in calcestruzzo liscio



Stone collection

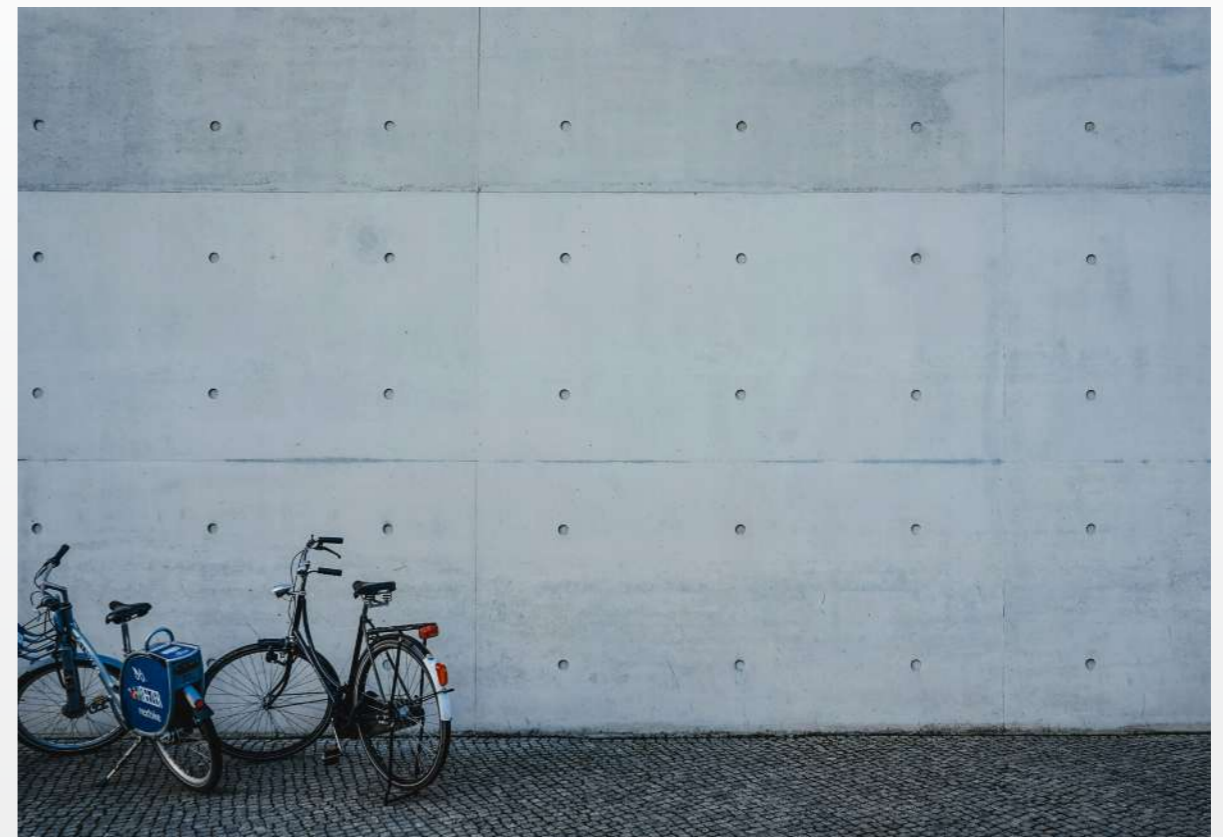

Linea matrici ALTORILIEVO.

Linea di matrici mono-getto dai rilievi molto accentuati, disponibili in 14 tipi di finiture, abbelliscono il calcestruzzo in modo semplice ed economico. Adatte per tutti i tipi di calcestruzzo, anche auto-compattanti, sono garantite per minimo un getto. Posa facile e veloce sui casseri tramite chiodi o con l'apposito adesivo, non necessitano disarmante e quindi i muri possono venire eventualmente tinteggiati immediatamente dopo il disarmo.

Le finiture della serie ALTORILIEVO conferiscono ad una costruzione un gradevole effetto. Possono essere posate all'interno delle casseforme in modo verticale, orizzontale o inclinate, per raggiungere il grado di personalizzazione desiderato. Ideali anche per la realizzazione di muri fonoassorbenti.

Le matrici ALTORILIEVO sono realizzate tramite accoppiatura di una lastra rigida in polistirene HIPS (lato getto) a un supporto in polistirolo ad alta densità.

Le sezioni indicate sono riferite alle matrici.

MOD. 04E

• 4000 x 1200 mm

Dettaglio del getto

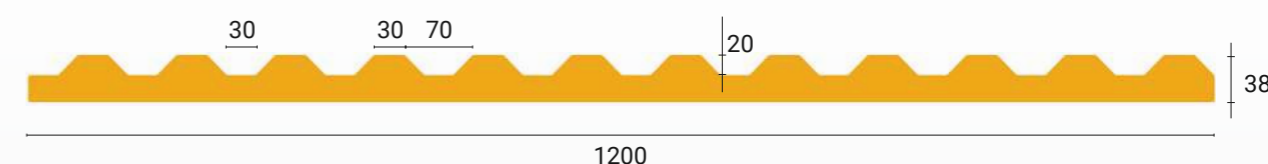
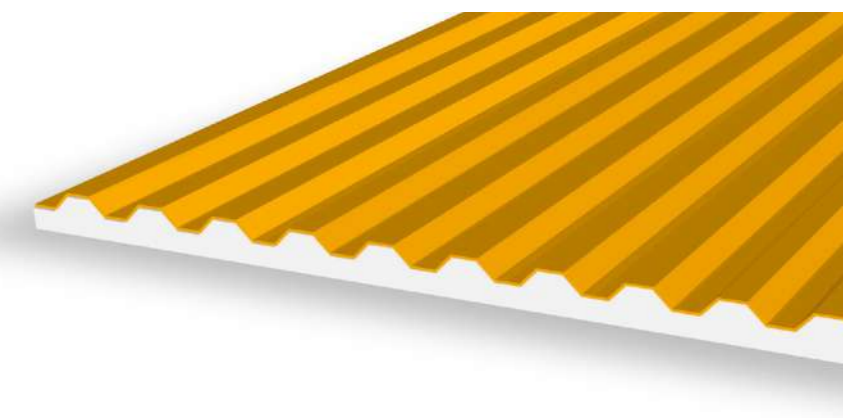
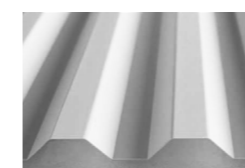

MOD. 05E

• 4000 x 1140 mm

Dettaglio del getto

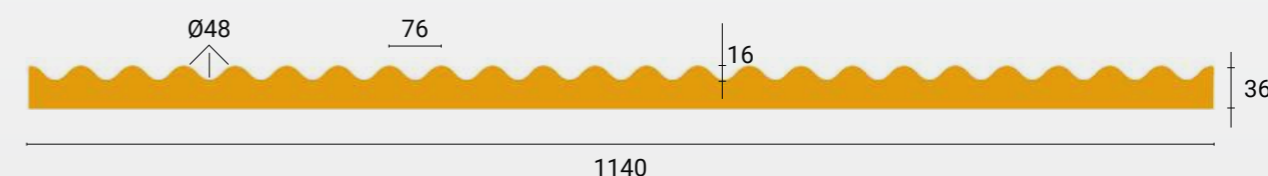
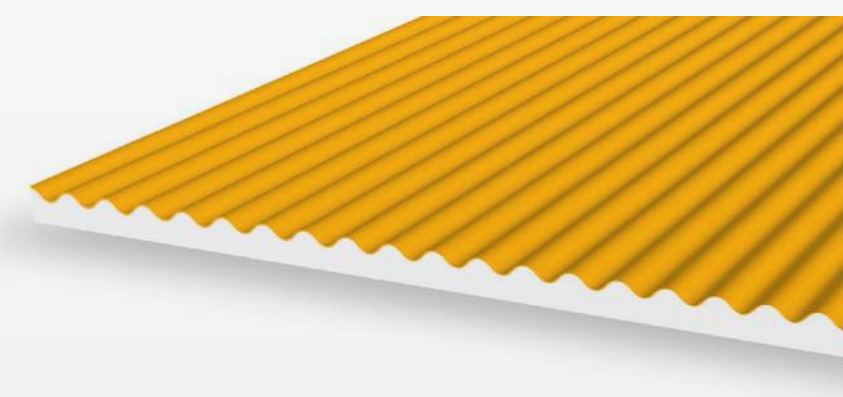
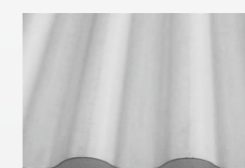

MOD. 06E

• 4000 x 1230 mm

Dettaglio del getto

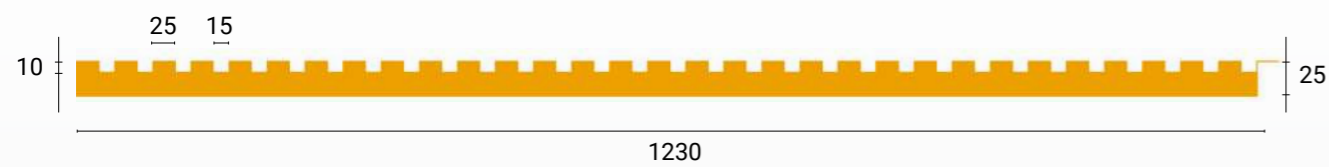
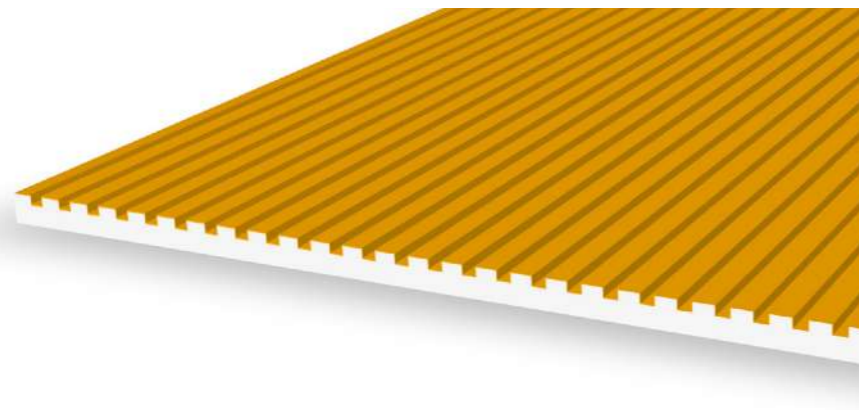
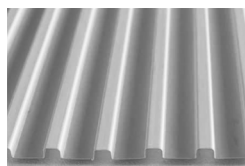

MOD. 09E

• 4000 x 1185 mm

Dettaglio del getto

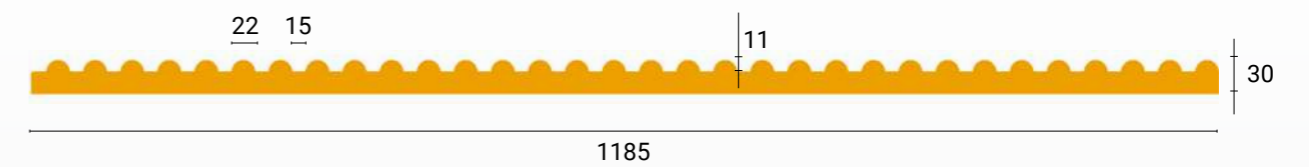
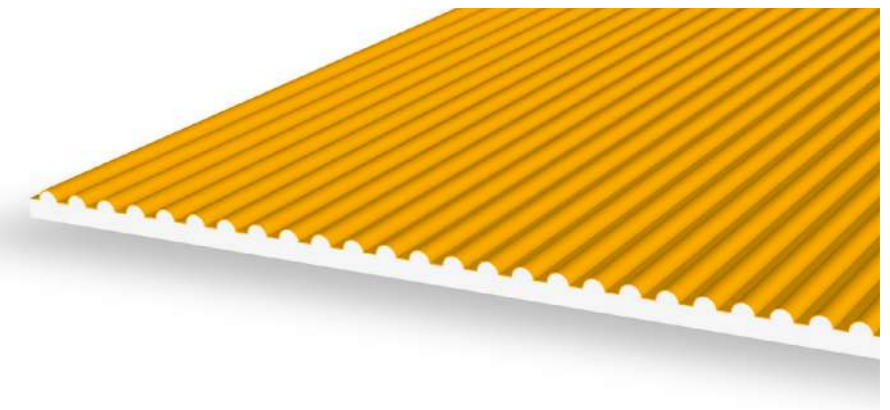
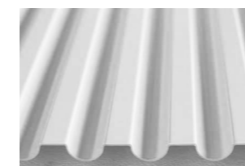

MOD. 08E

• 4000 x 1200 mm

Dettaglio del getto

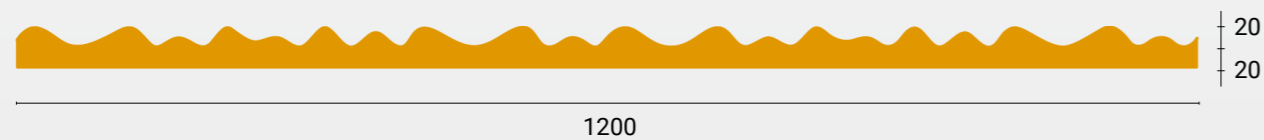
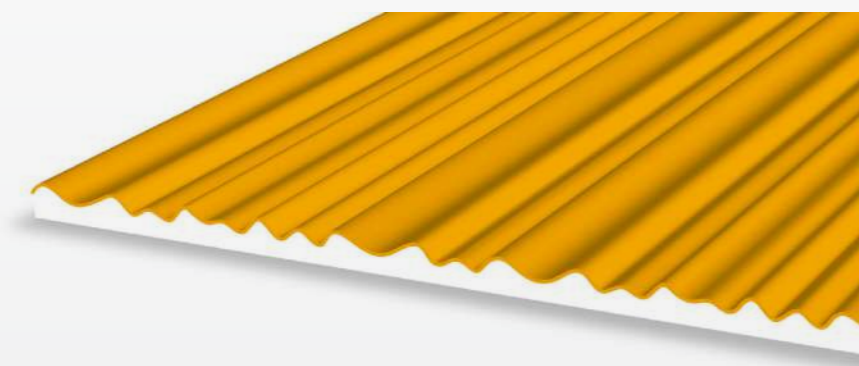

MOD. 10E

• 4000 x 1250 mm

Dettaglio del getto

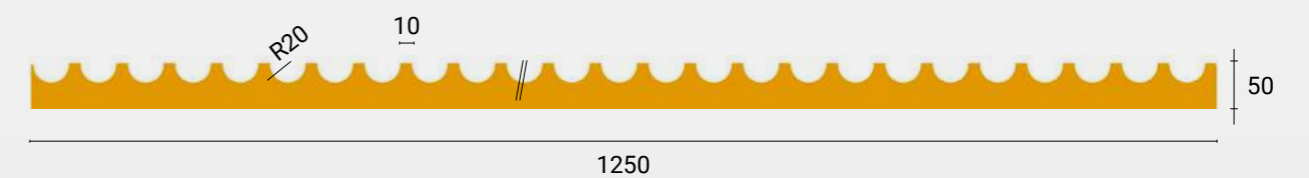
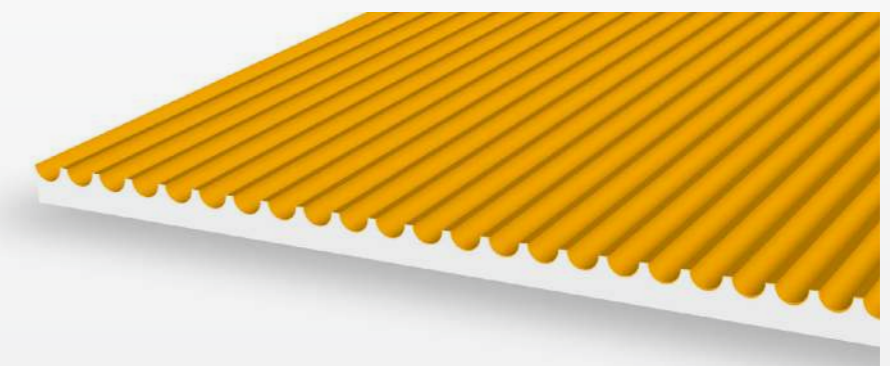
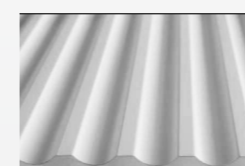

MOD. 11E

• 4000 x 1220 mm

Dettaglio del getto

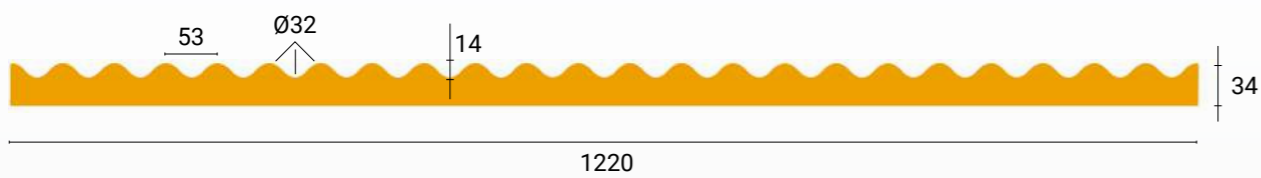
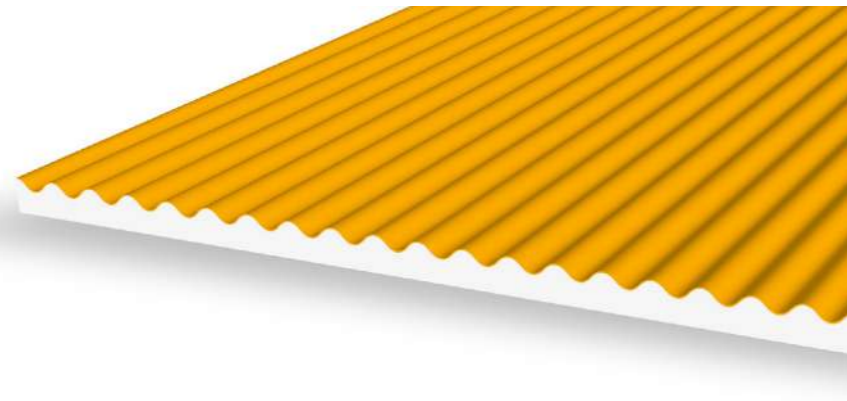
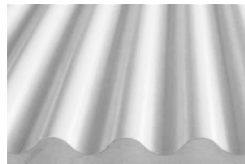

MOD. 14E

• 4000 x 1210 mm

Dettaglio del getto

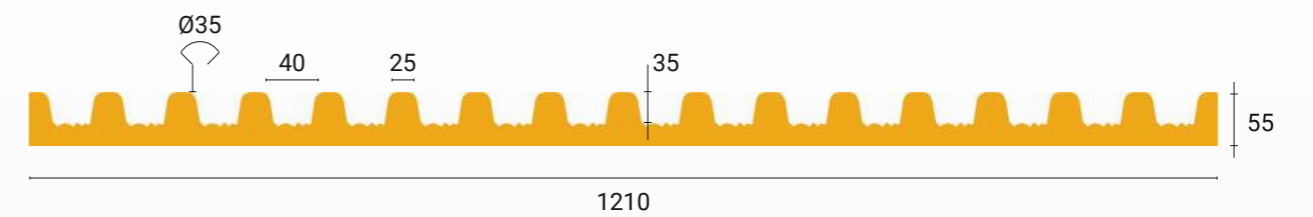
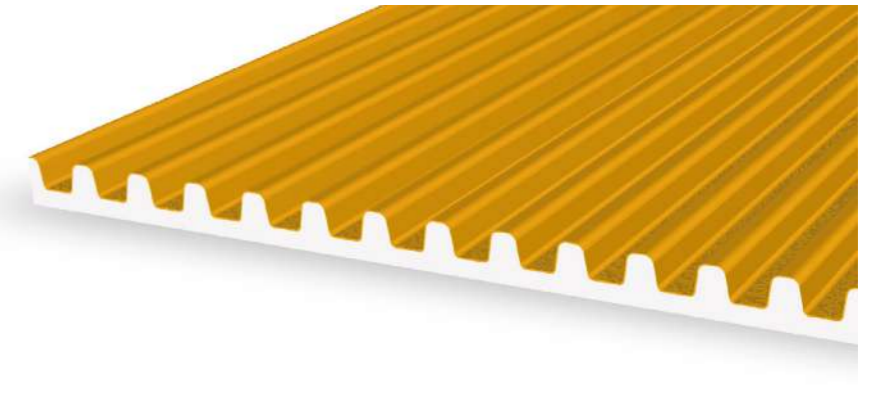
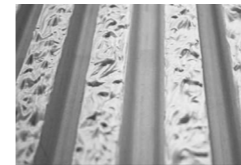

MOD. 13E

• 4000 x 1200 mm

Dettaglio del getto

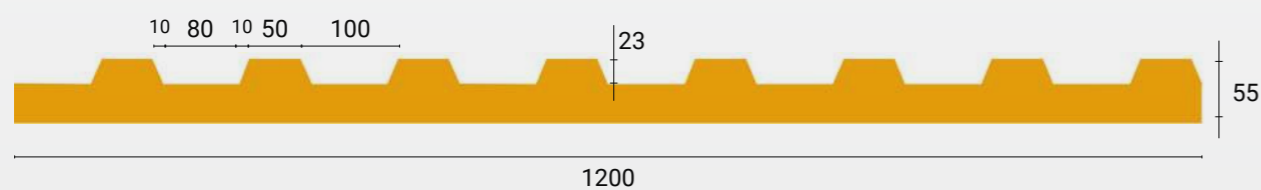
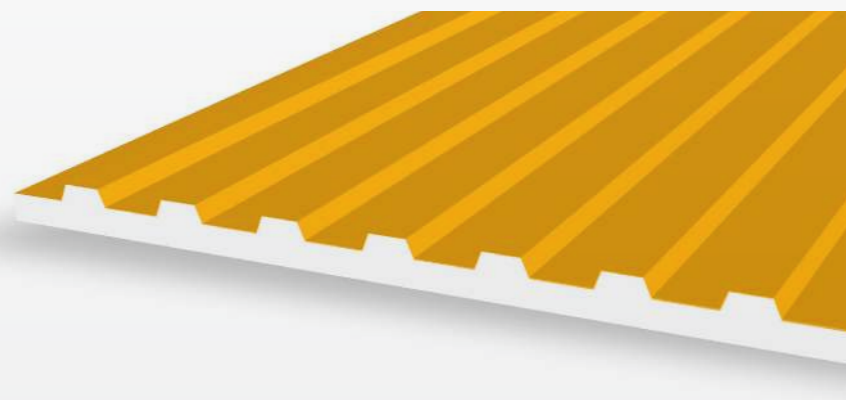
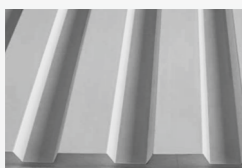

MOD. 15E

• 4000 x 1200 mm

Dettaglio del getto

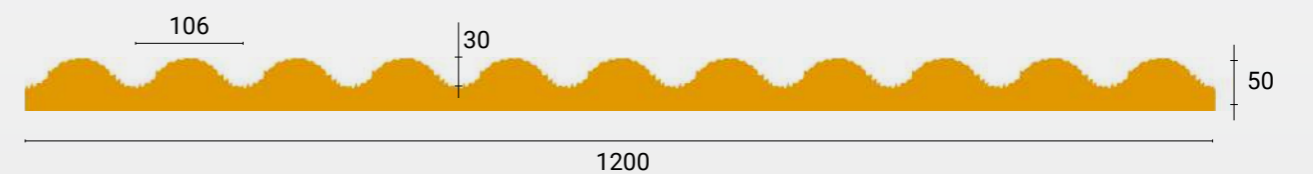
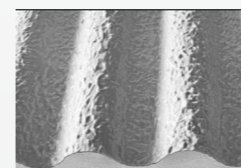

MOD. 16E

• 4000 x 1200 mm

MOD. 30E

• 4000 x 1150 mm

Dettaglio del getto

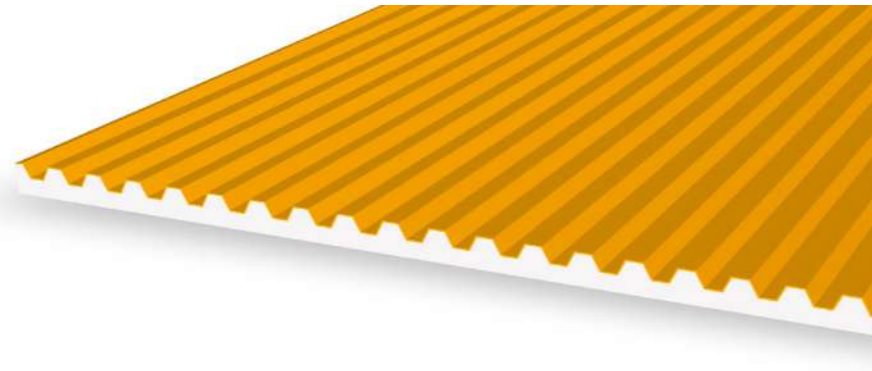
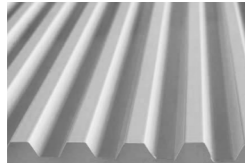

Dettaglio del getto

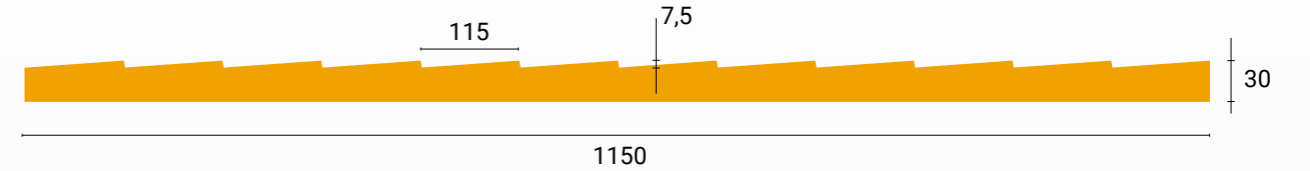
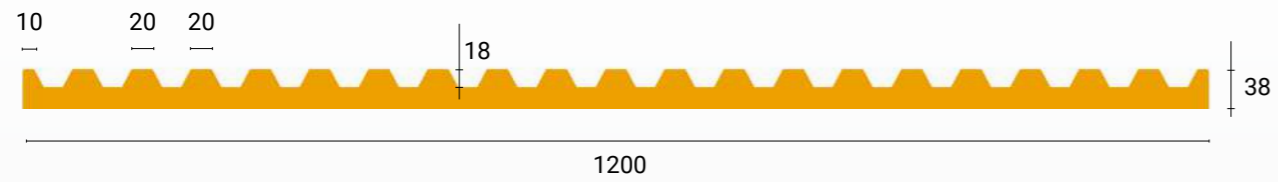
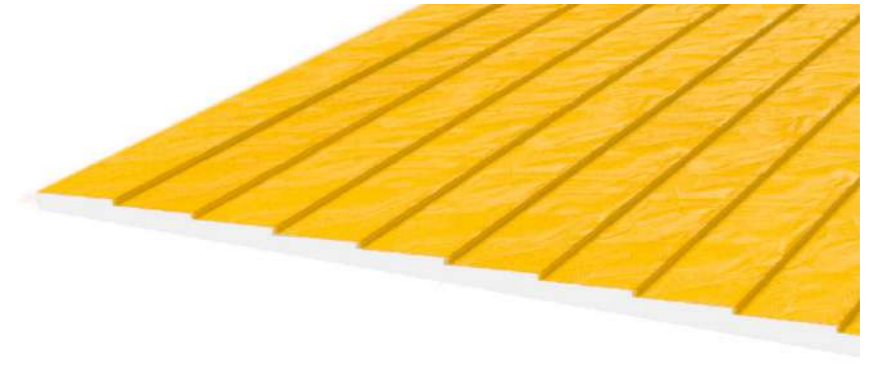
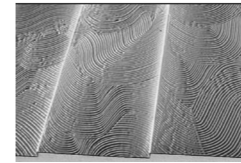

MOD. 24E

• 4000 x 1200 mm

MOD. 31E

• 4000 x 1150 mm

Dettaglio del getto

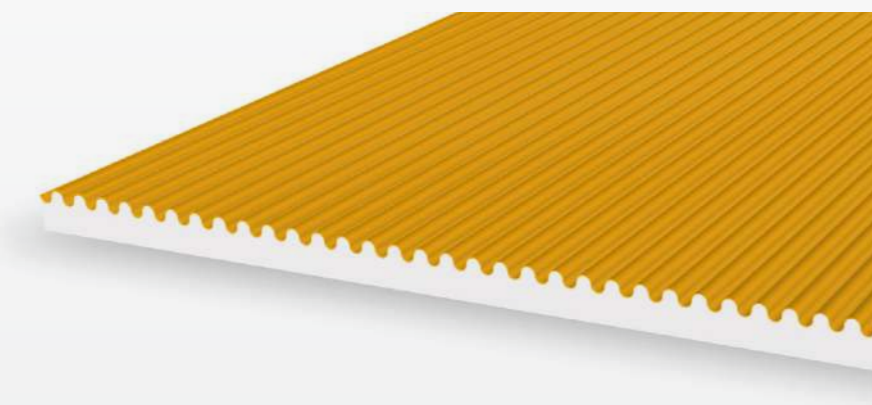
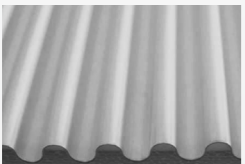

Dettaglio del getto

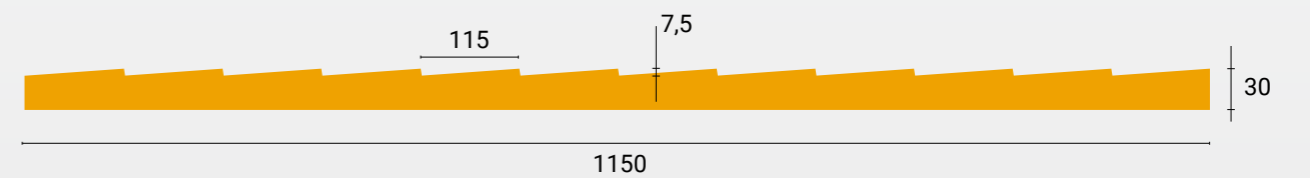
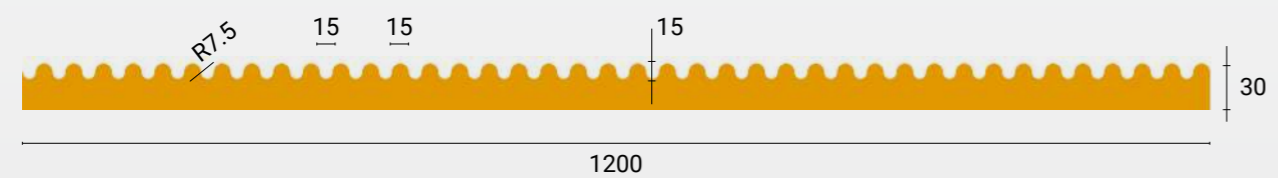
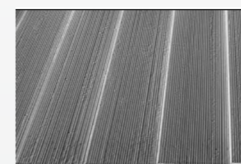

MOD. 62E

• 4000 x 1200 mm

Dettaglio del getto

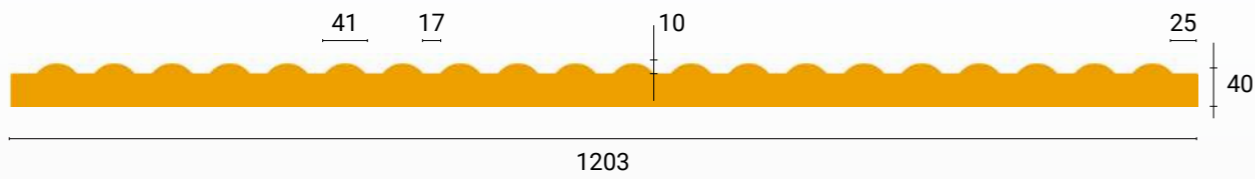
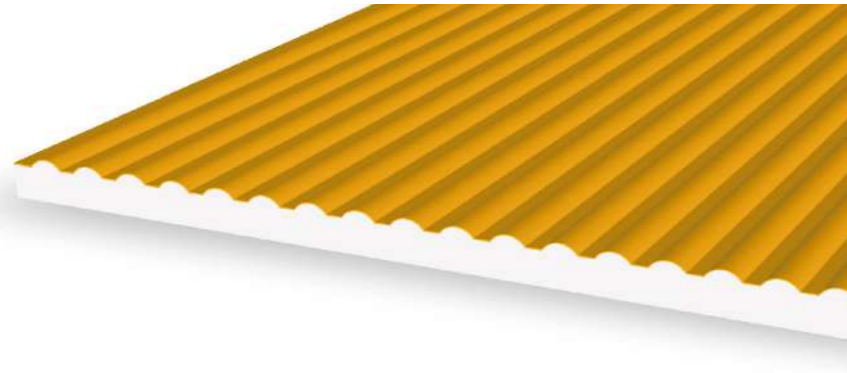
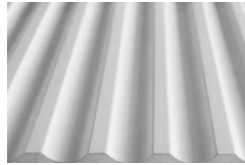

MOD. 69E

• 4000 x 1200 mm

Dettaglio del getto

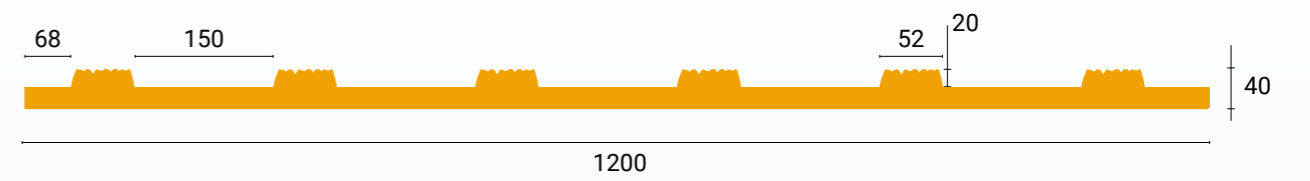
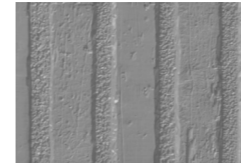

MOD. 67E

• 4000 x 1150 mm

Dettaglio del getto

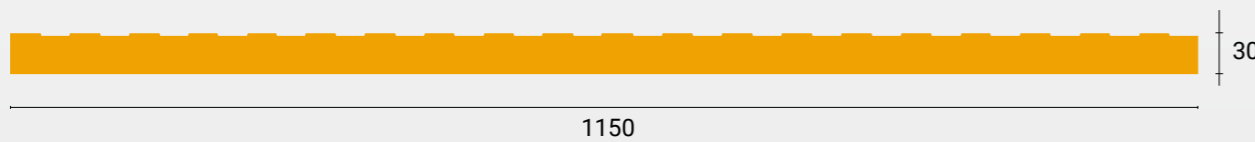

MOD. 70E

• 4000 x 1200 mm

Dettaglio del getto

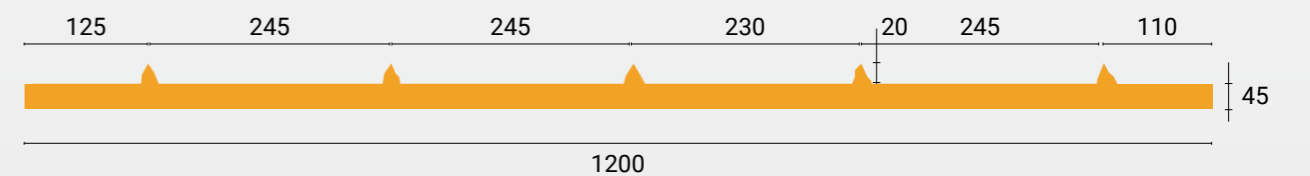

MOD. 71E

• 4000 x 1200 mm

Dettaglio del getto

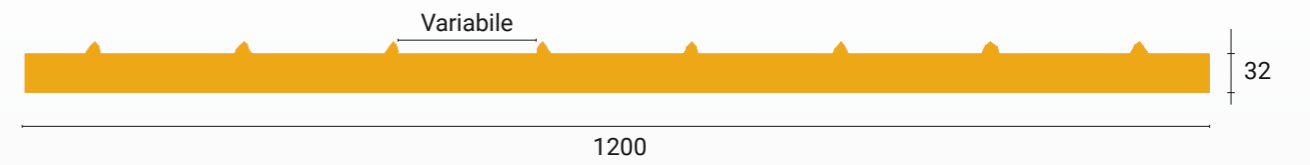
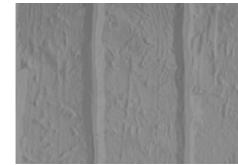

MOD. 80E

• 4000 x 1200 mm

Dettaglio del getto

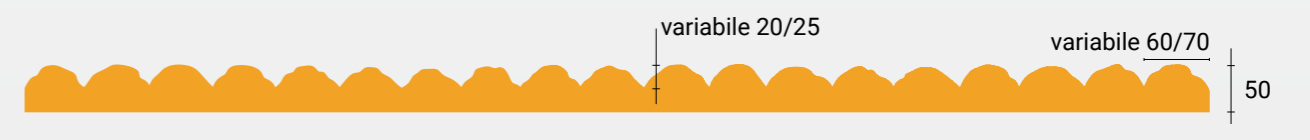
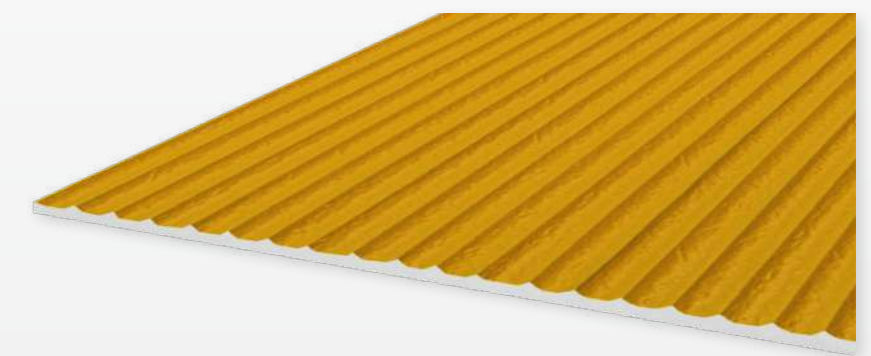
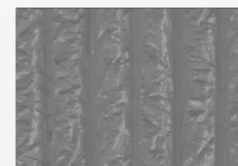

BETON·UNO



BETON·UNO

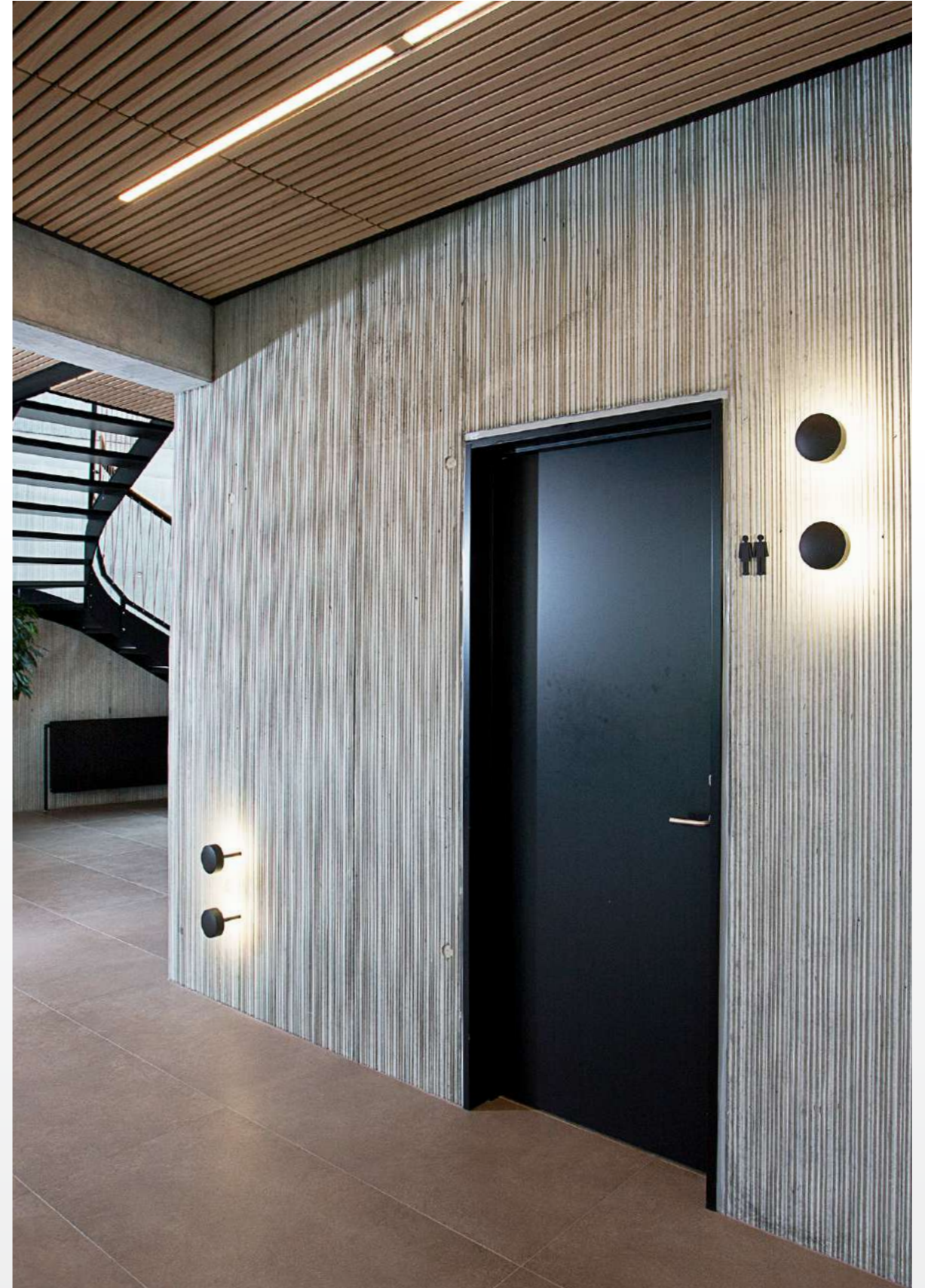

11/25 BETON UNO

Beton Uno div. Virage Srl

Via Treves 72 - 20090 Trezzano s/Naviglio (MI) / Tel. 02 4840 3101 / info@beton-uno.it
P. Iva/Cod. Fisc./Reg. Impr. Mi IT13360840154 CCIAA Milano R.E.A. - n. 1644962 Cap. soc. Euro 10.000,00 i.v.